

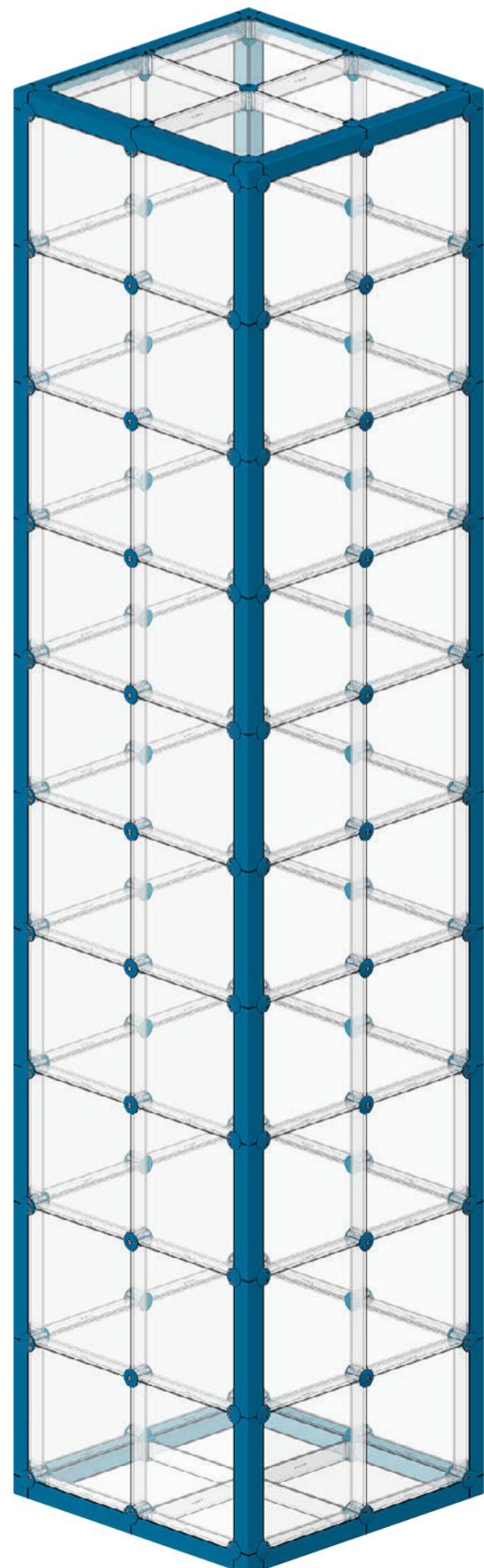

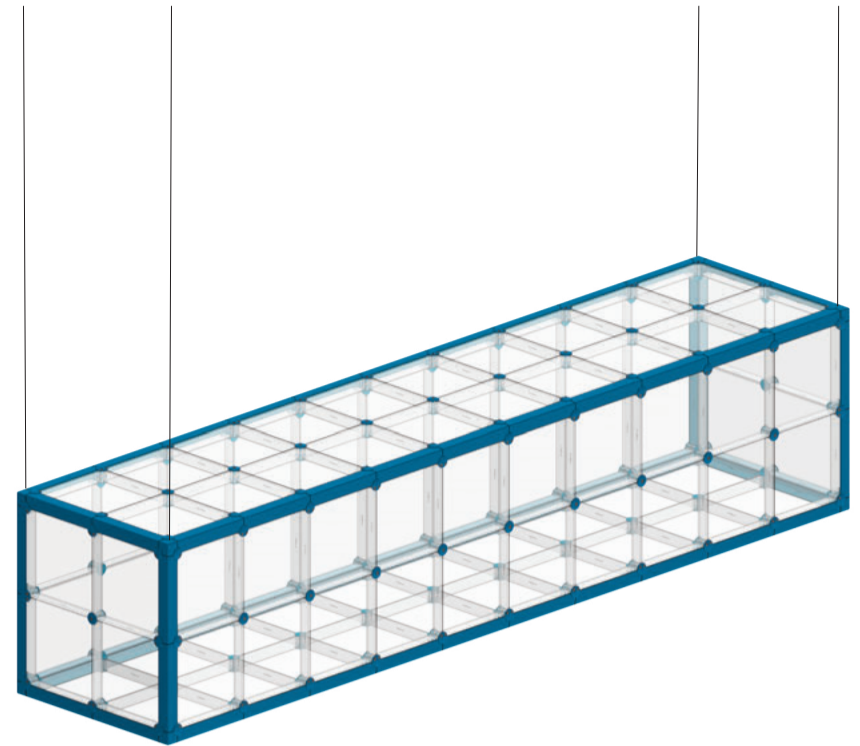

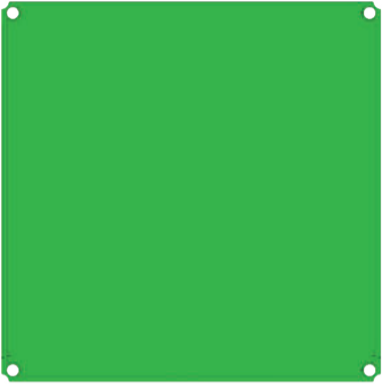

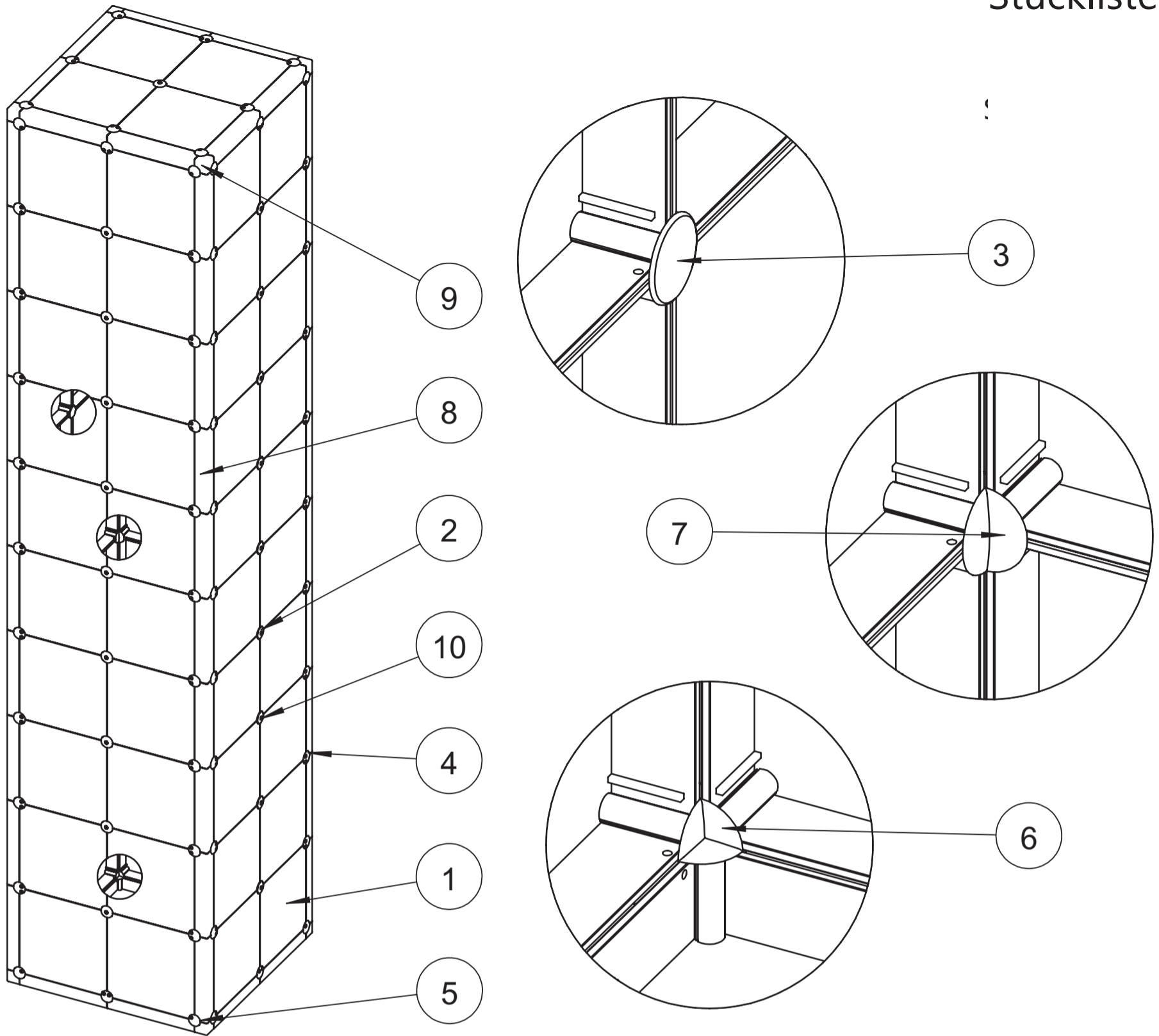



Lichtsäule  
Lampe



# Stückliste



| POS-NR. | BENENNUNG                     | ART.-NR. | MENGE |   |
|---------|-------------------------------|----------|-------|---|
| 1       | Cassette                      | X101.04  | 88    |  |
| 2       | Standardverbinder Senkkopf    | X102.01  | 38    |  |
| 3       | Standardverbinder             | X102.02  | 38    |  |
| 4       | Standardverbinder 2 Senkungen | X102.03  | 88    |  |
| 5       | Standardverbinder 1 Senkung   | X102.04  | 24    |  |
| 6       | Innenverbinder 3-Fach         | X102.13  | 8     |  |
| 7       | Innenverbinder 4-Fach         | X102.14  | 44    |  |
| 8       | Eckschiene                    | X103.01  | 56    |  |
| 9       | Kofferecke                    | X103.02  | 8     |  |
| 10      | Schraube                      |          | 238   |  |

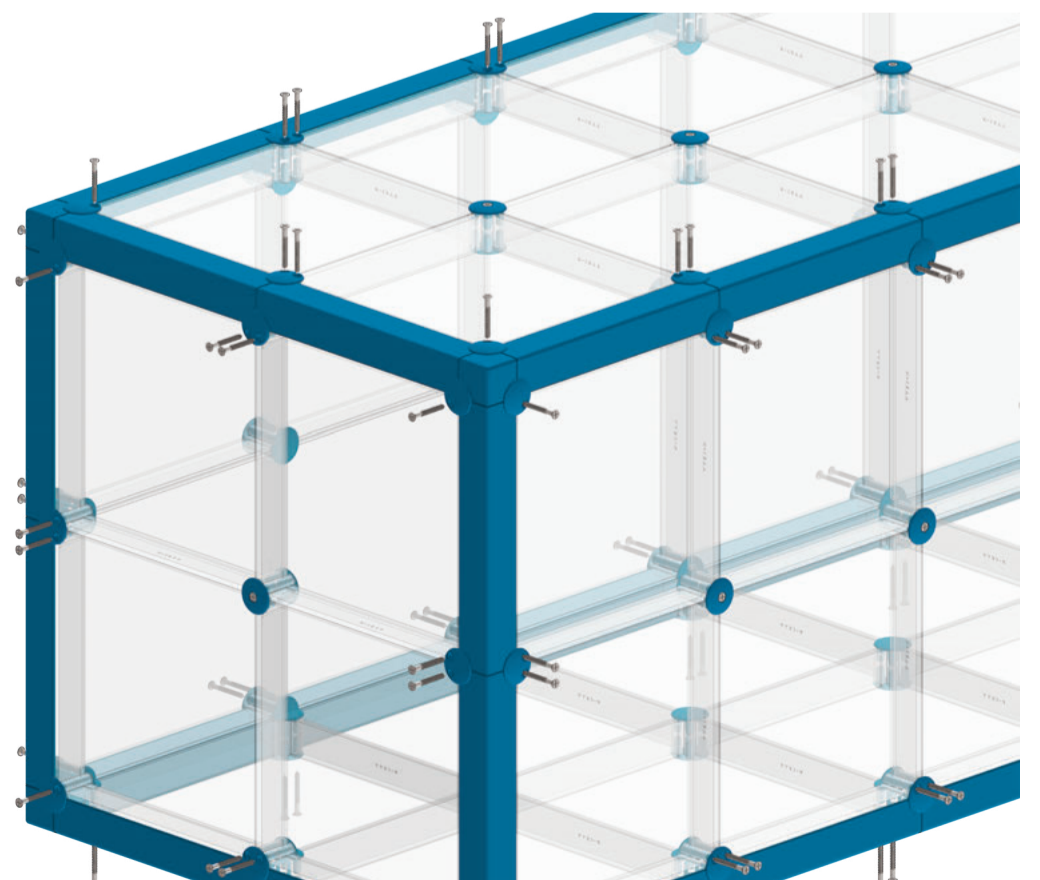
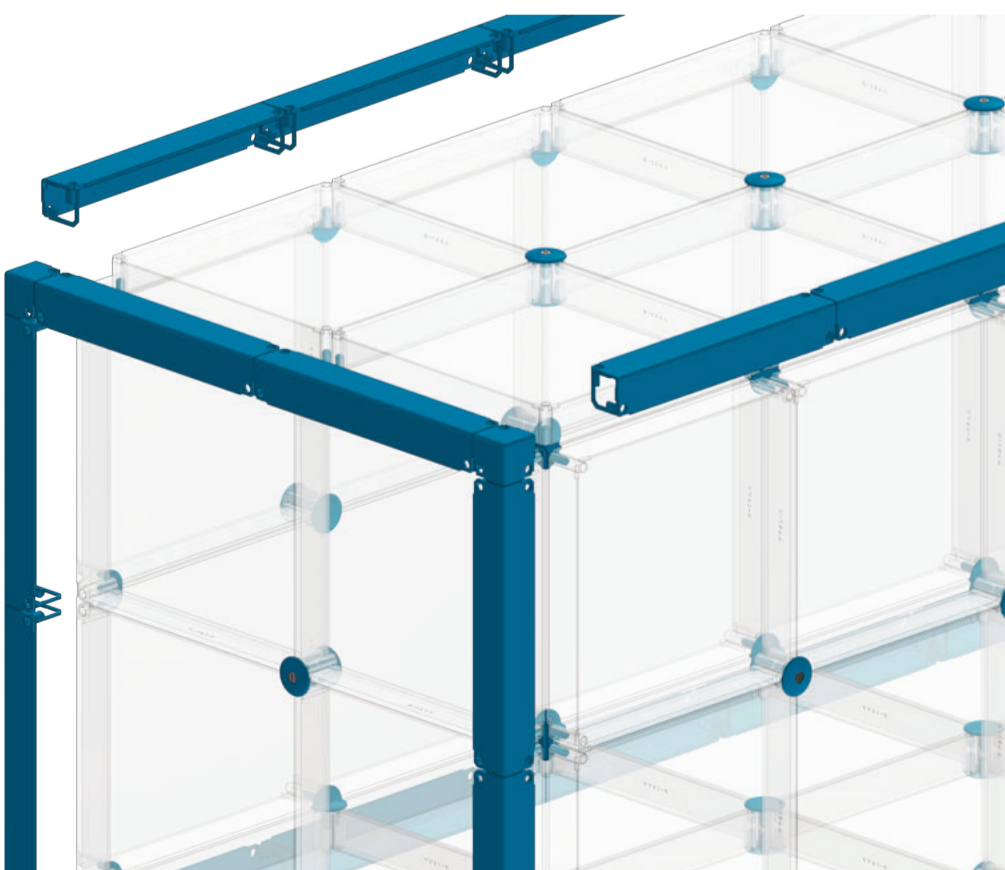
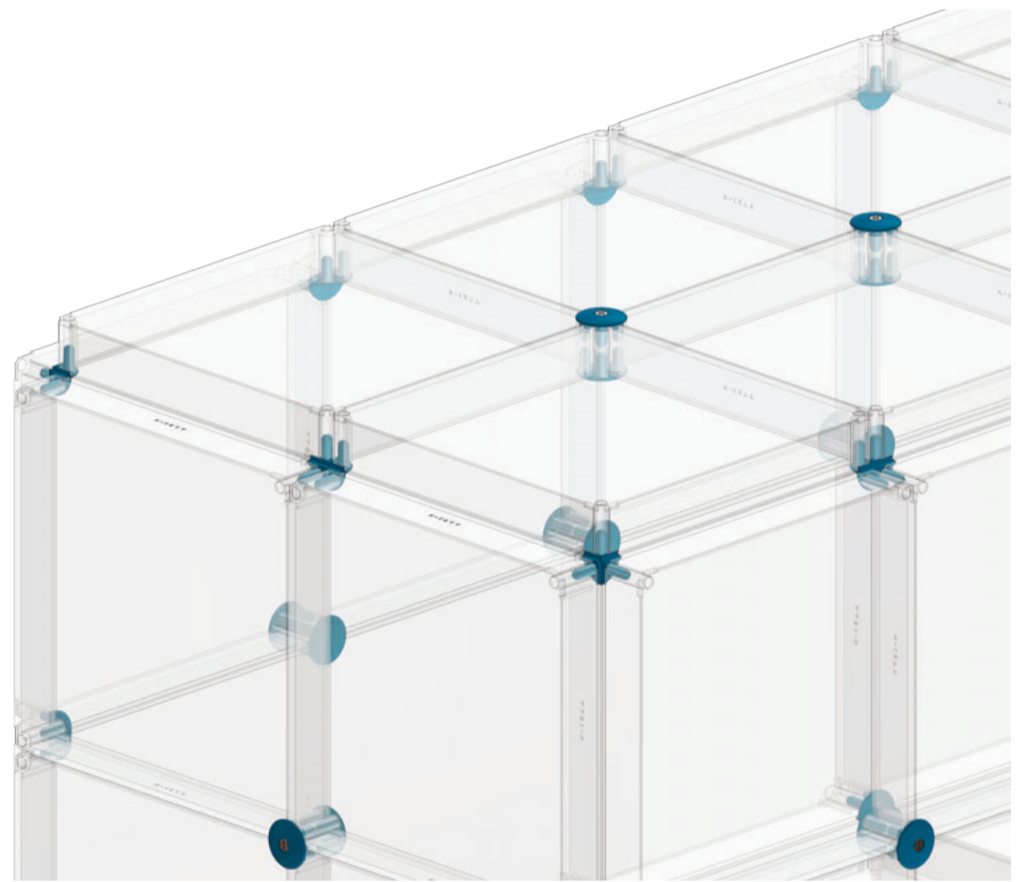
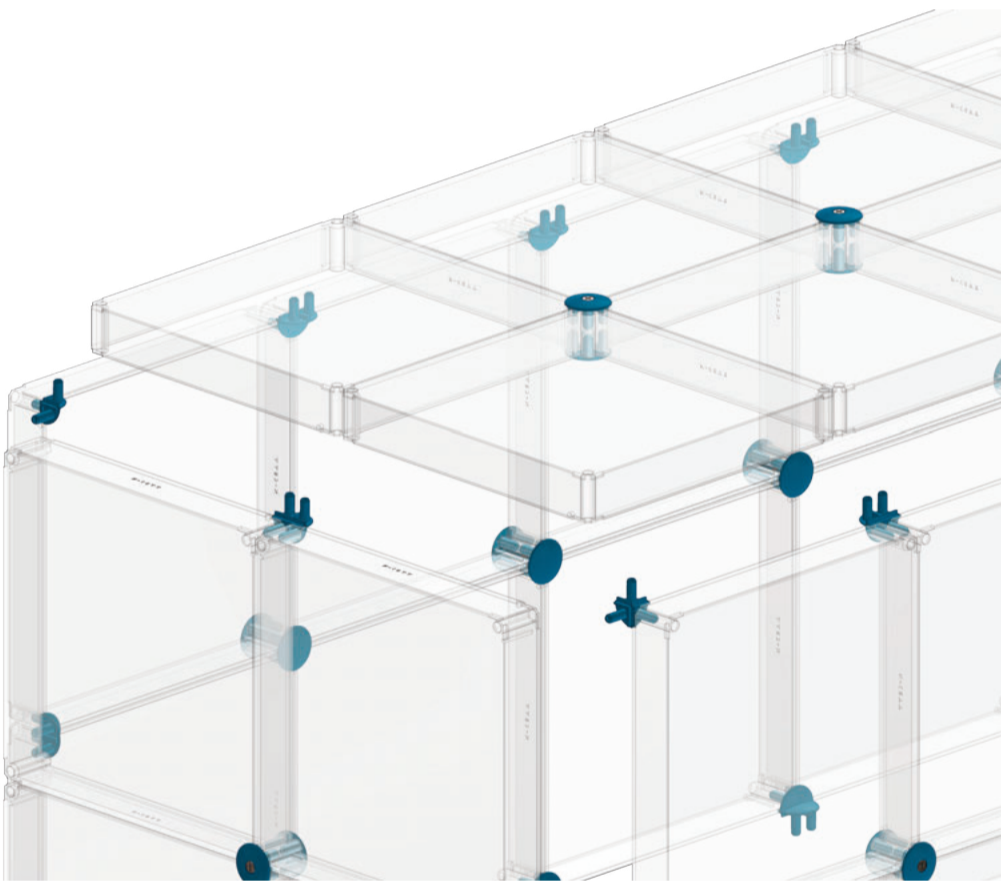
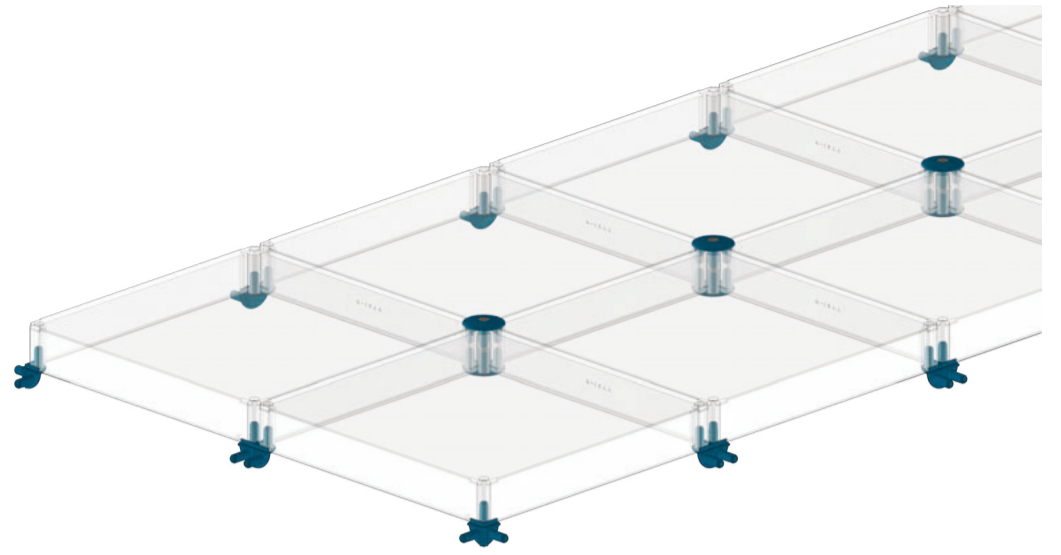
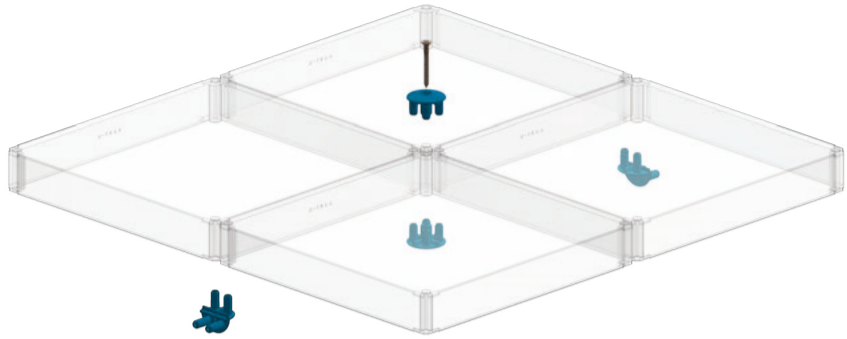

-Werkzeug  
-Reinigung

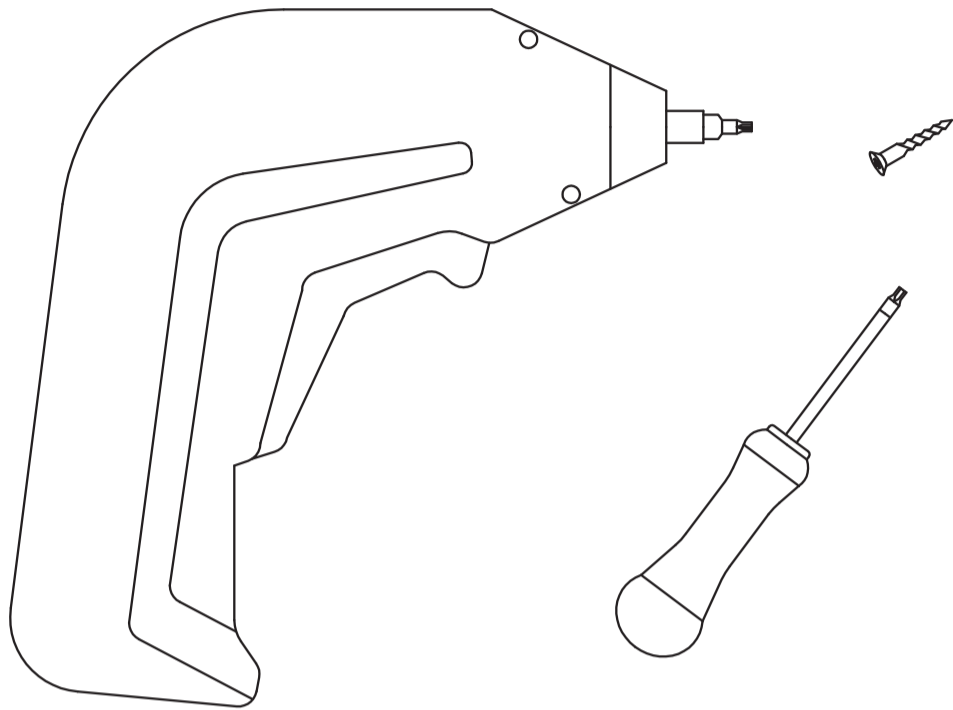

Benötigte Schrauben:  
SPAX T 10 ; 3 x 25

Benötigtes Werkzeug:  
Schraubendreher T 10

Maximales Drehmoment:  
1 Nm

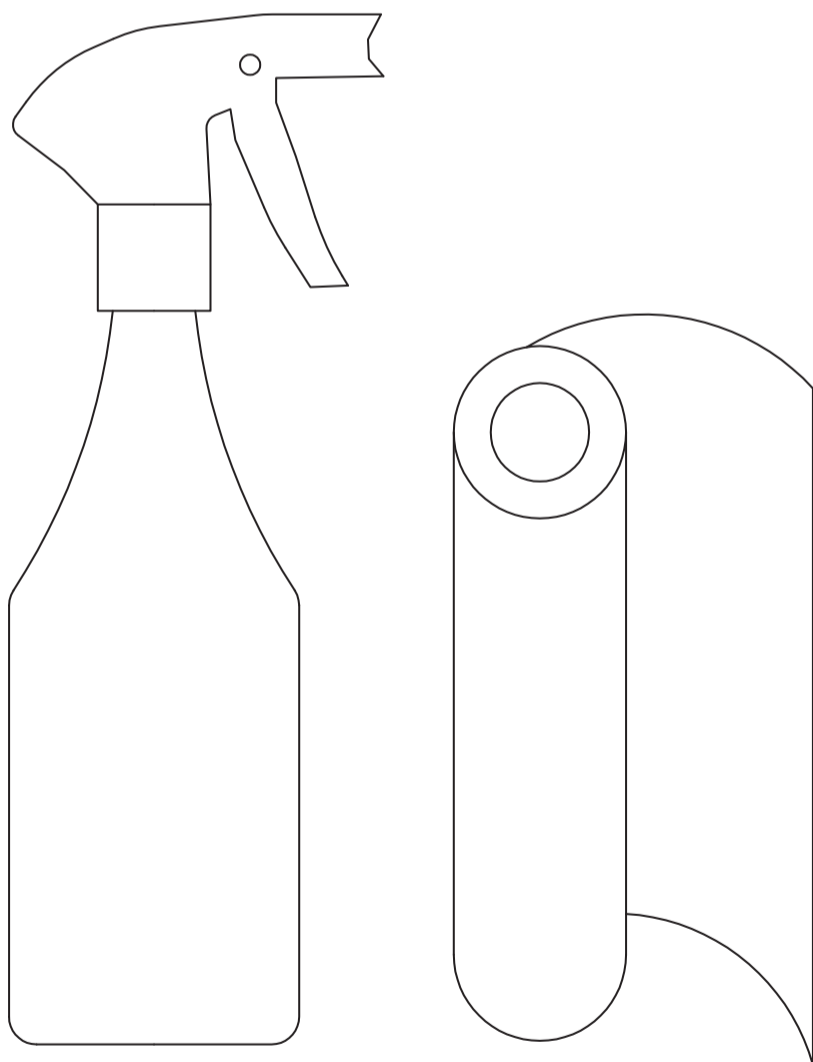

Reinigung der Systembauteile:

wie bei Autoscheinwerfern, mit  
Wasser und Shampoo und einem  
weichen Tuch.

xx niemals mit Lösungsmitteln xx

X-CETT Germany

Schreck Form e.K. Fon.: +49 6451 7186888 ; E-Mail: info@schreck-form.com ; www.X-Cett.com