

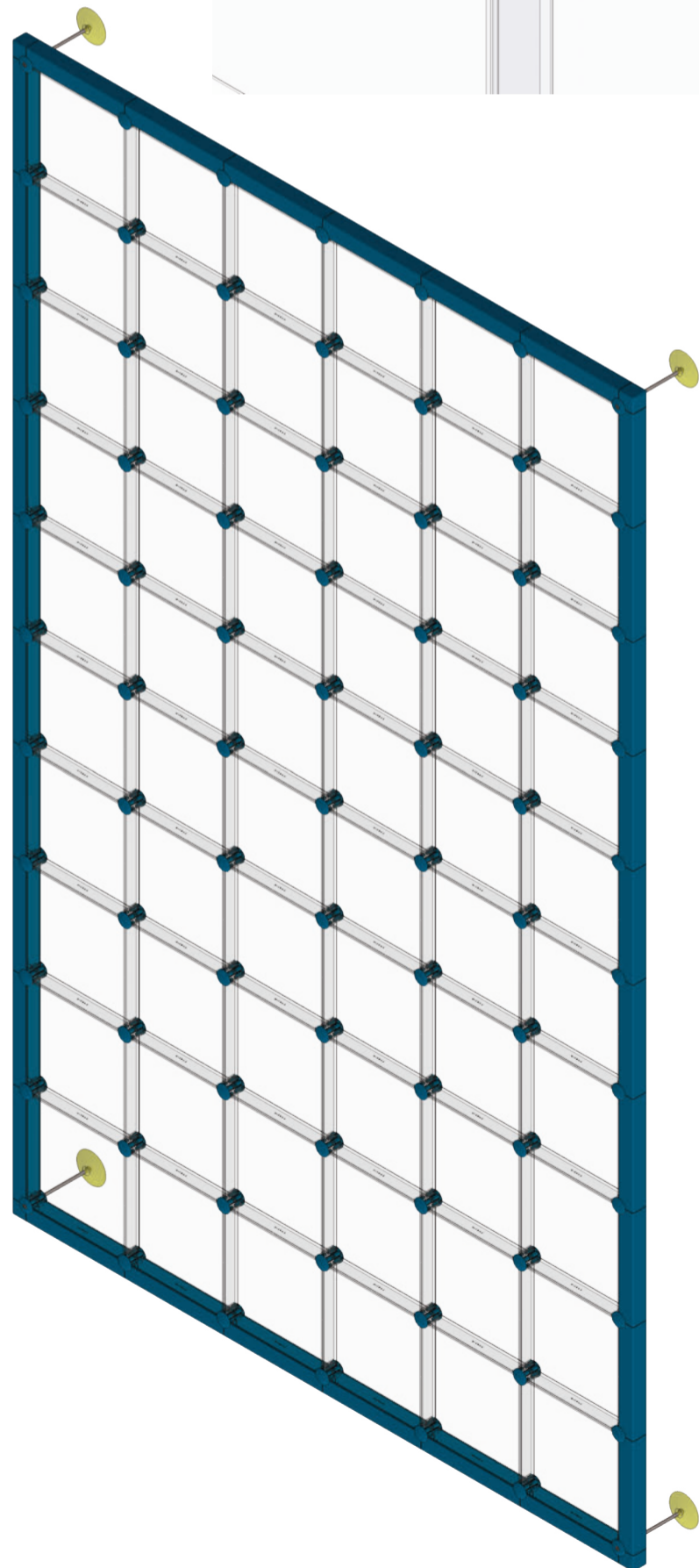

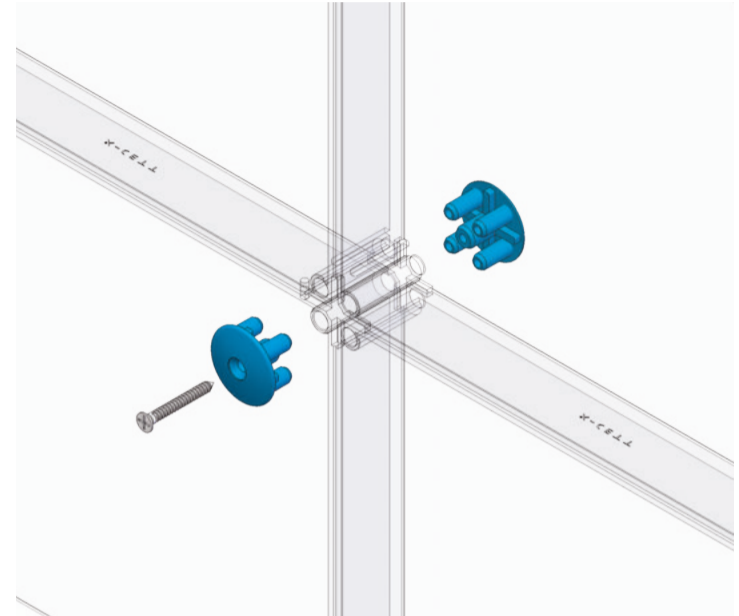

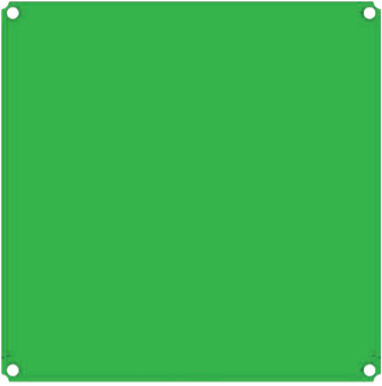

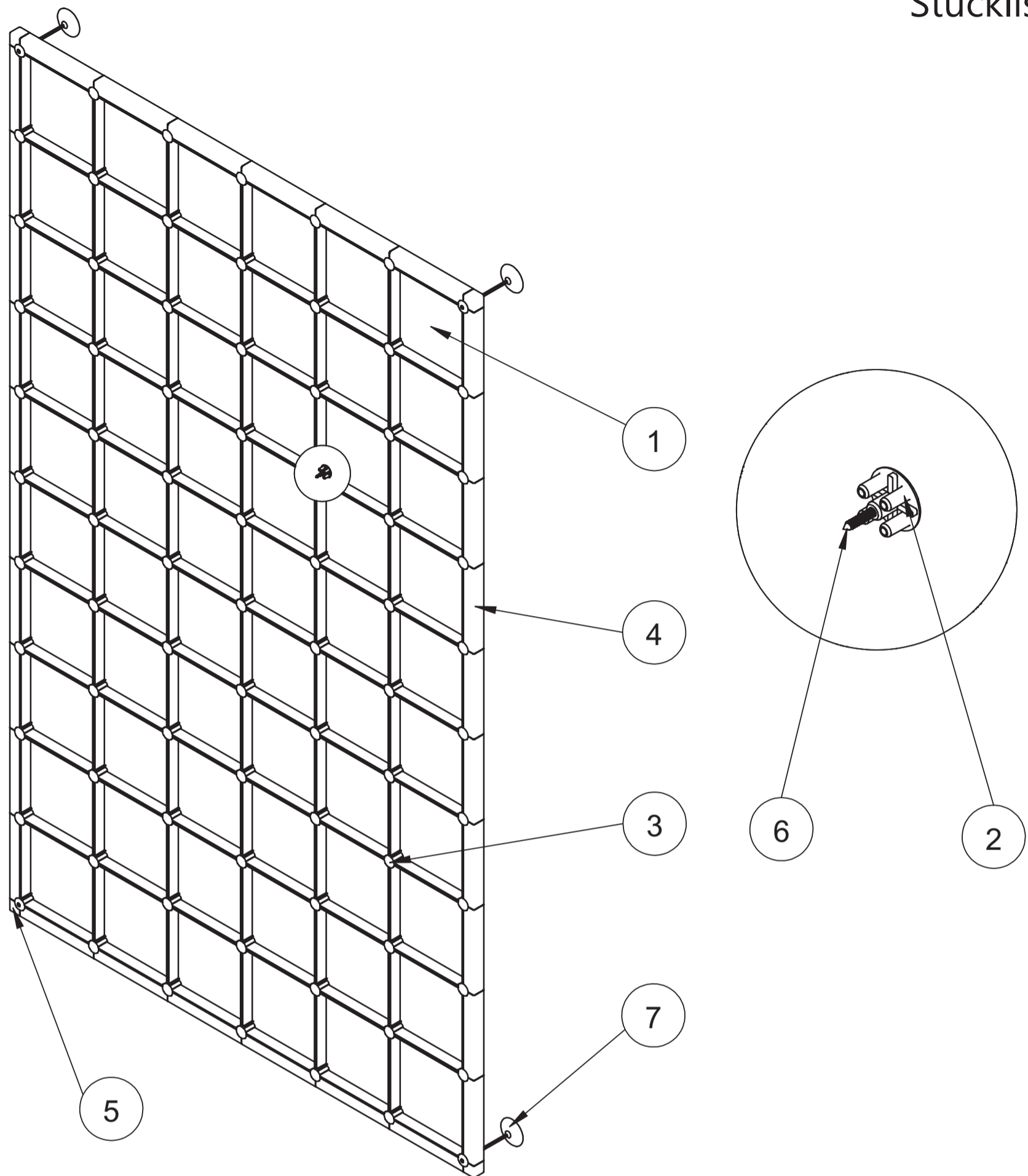

Sichtschutz Infotafel



Stückliste



POS-NR.	BENENNUNG	ART.-NR.	MENGE	
1	Cassette	X101.04	60	
2	Standardverbinder Senkkopf	X102.01	81	
3	Standardverbinder	X102.02	73	
4	U-Schiene	X104.01	32	
5	U-Ecke	X104.02	4	
6	Schraube		77	
7	Saugnapf		4	

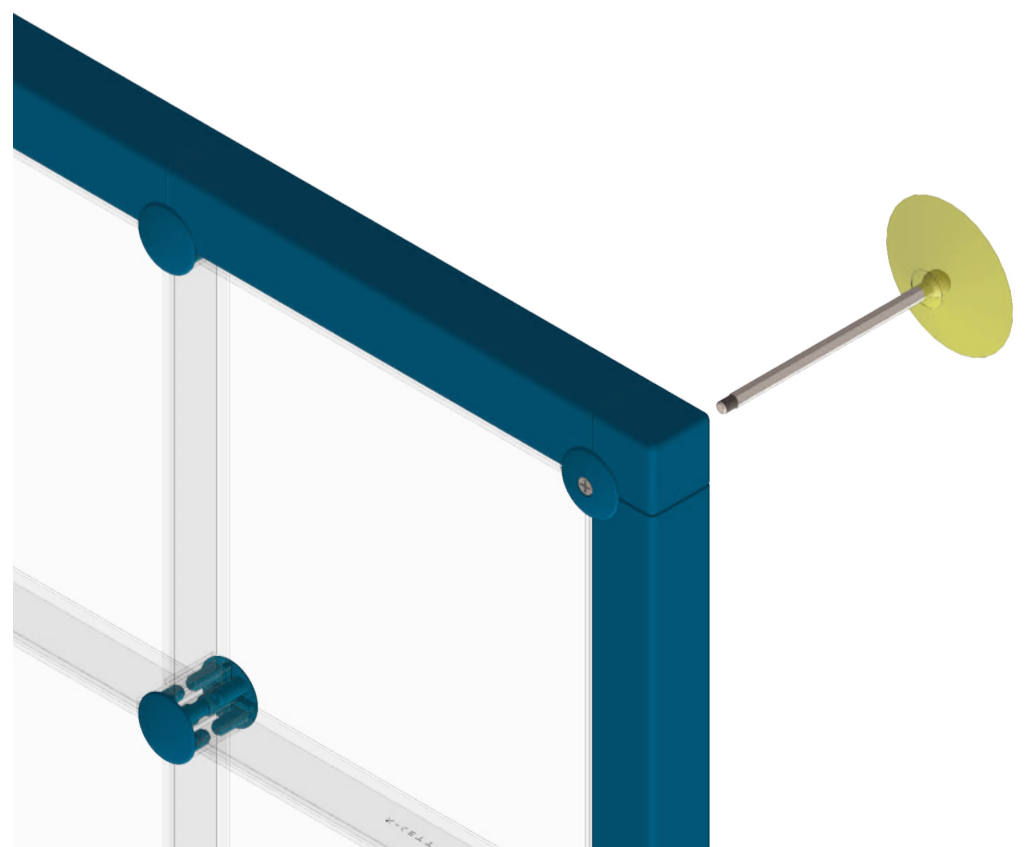
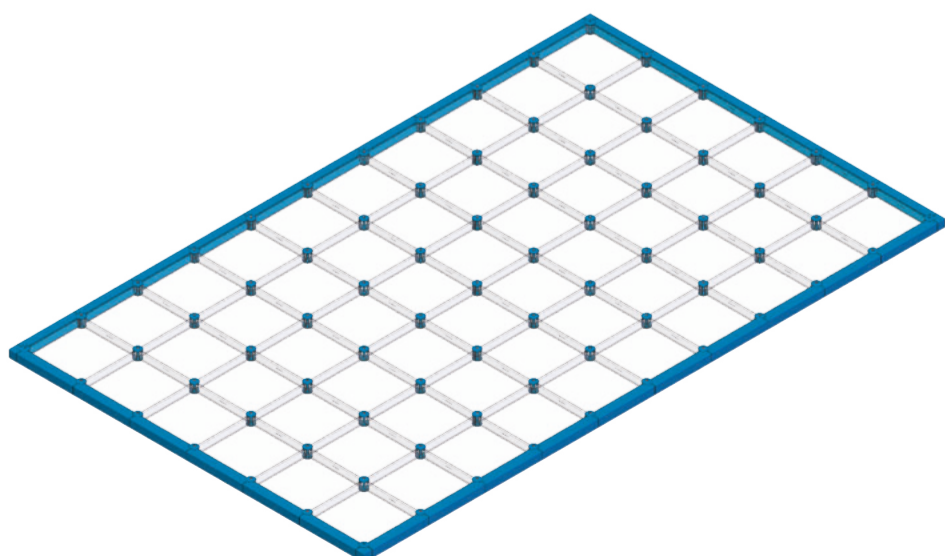
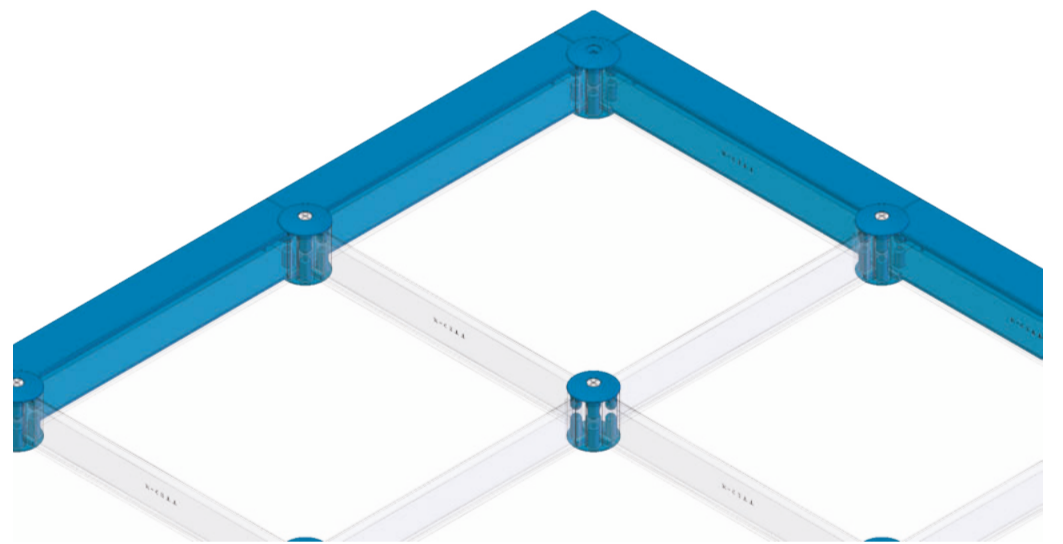
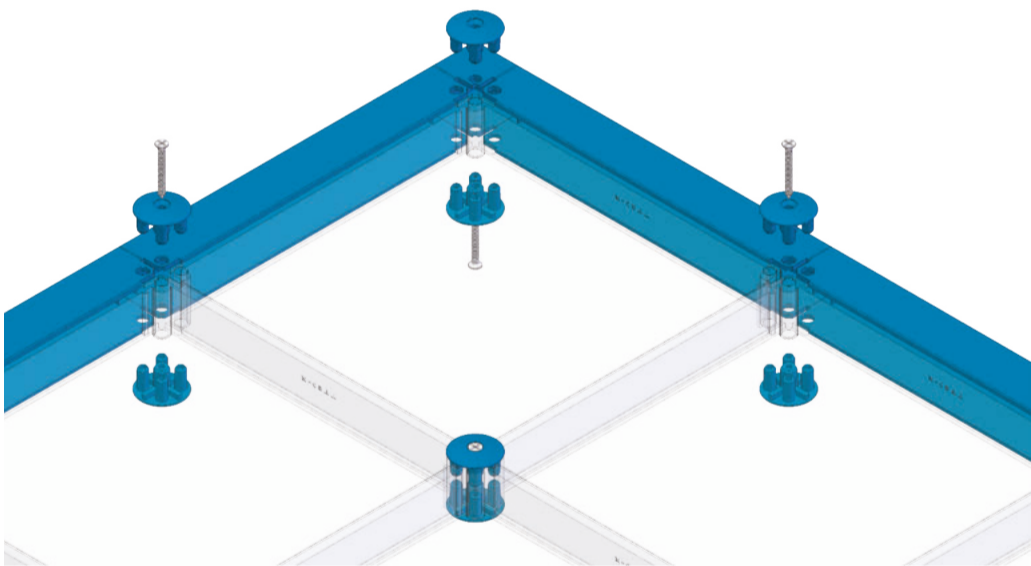
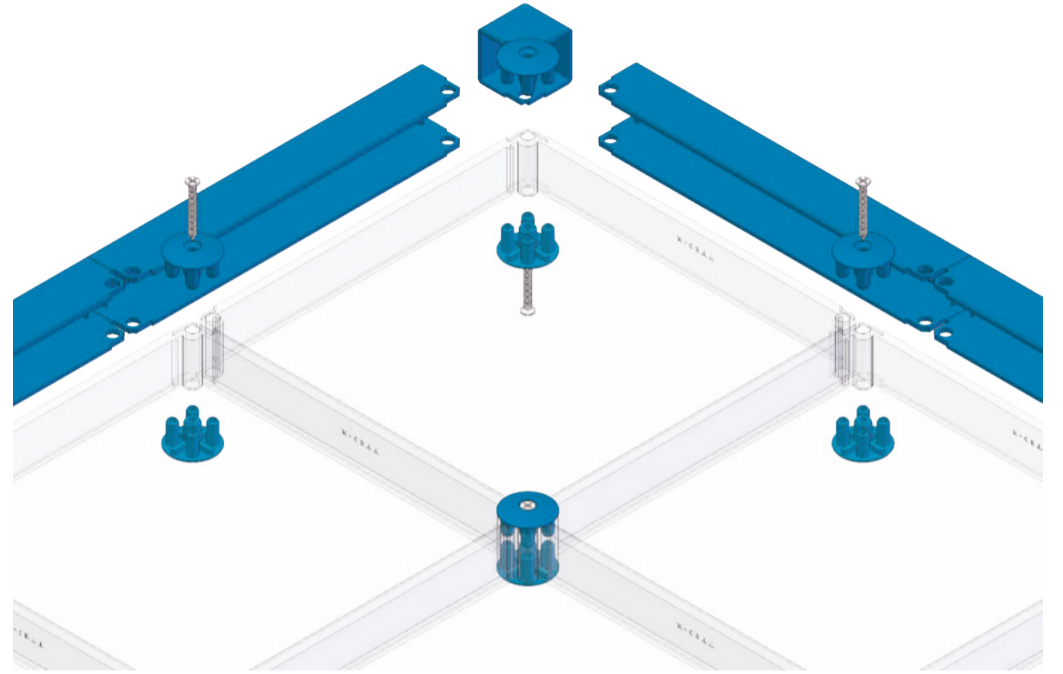
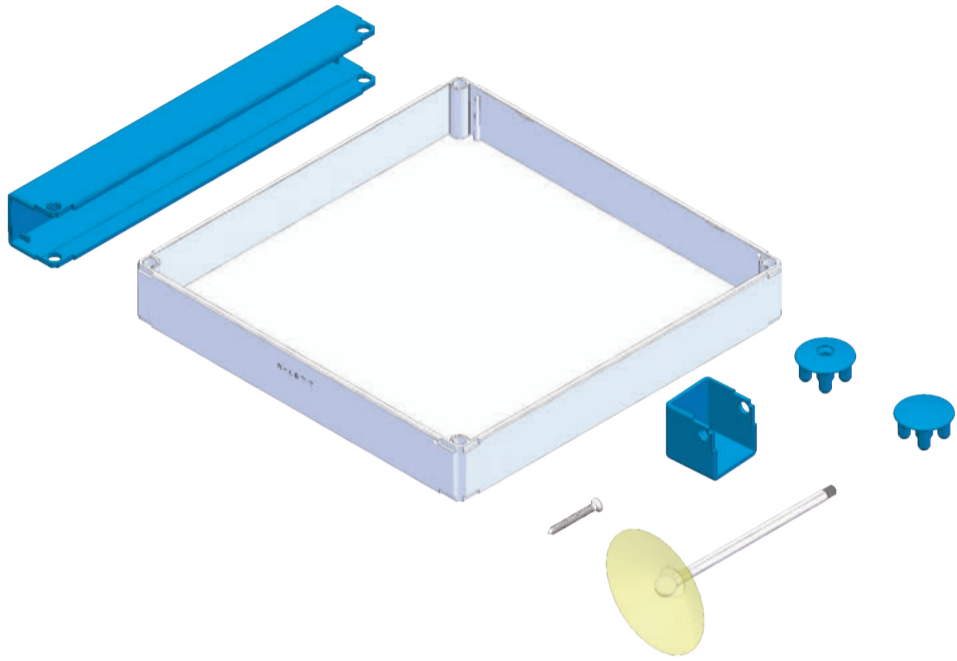

-Werkzeug
-Reinigung

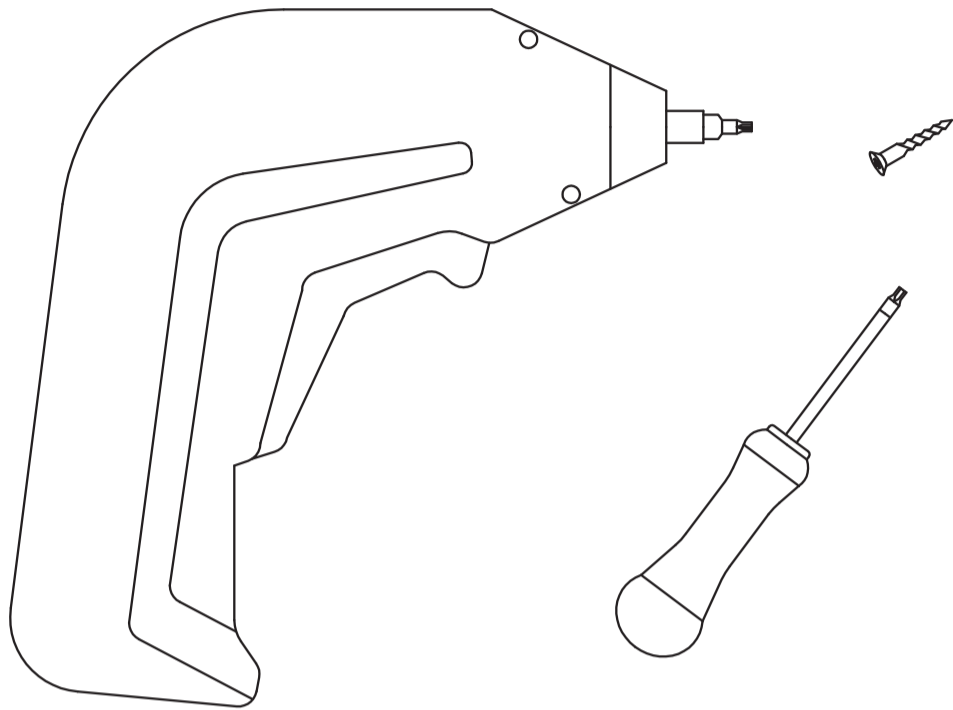

Benötigte Schrauben:
SPAX T 10 ; 3 x 25

Benötigtes Werkzeug:
Schraubendreher T 10

Maximales Drehmoment:
1 Nm

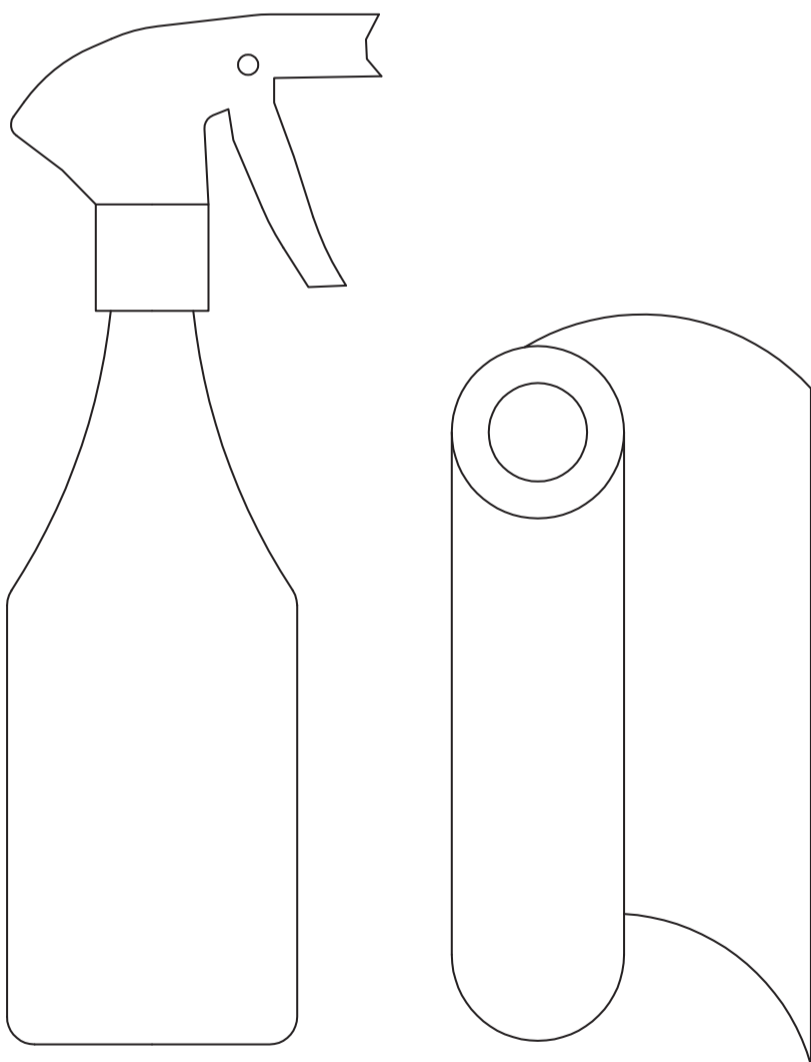

Reinigung der Systembauteile:

wie bei Autoscheinwerfern, mit
Wasser und Shampoo und einem
weichen Tuch.

xx niemals mit Lösungsmitteln xx

X-CETT Germany

Schreck Form e.K. Fon.: +49 6451 7186888 ; E-Mail: info@schreck-form.com ; www.X-Cett.com