

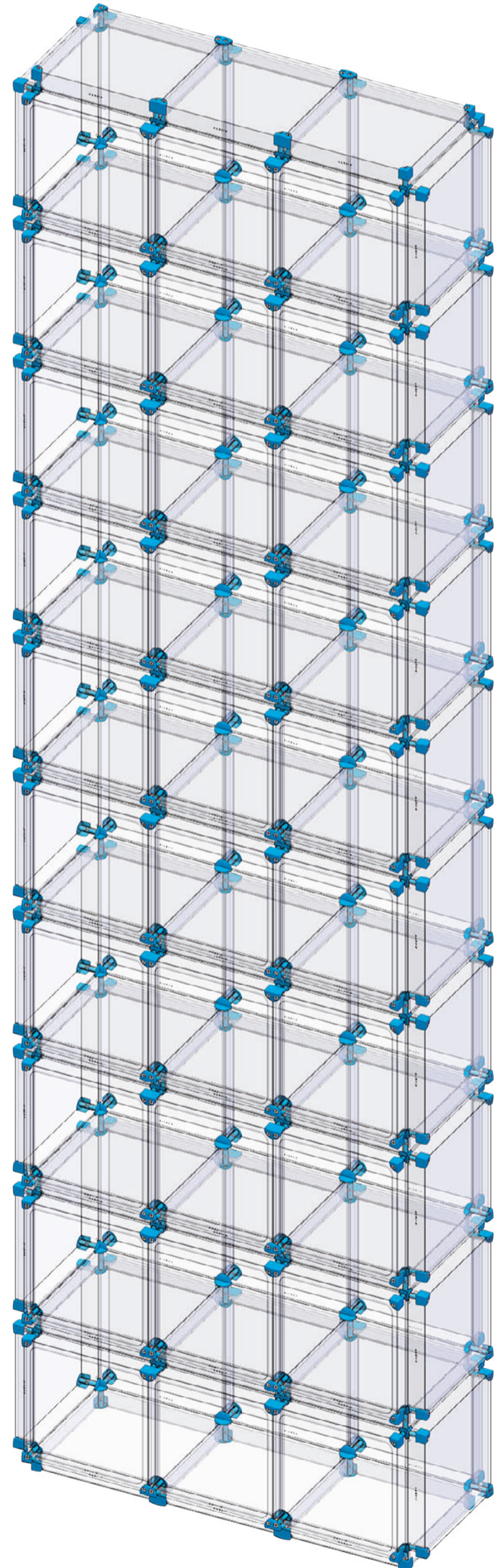

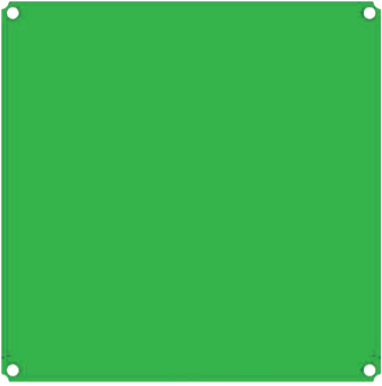

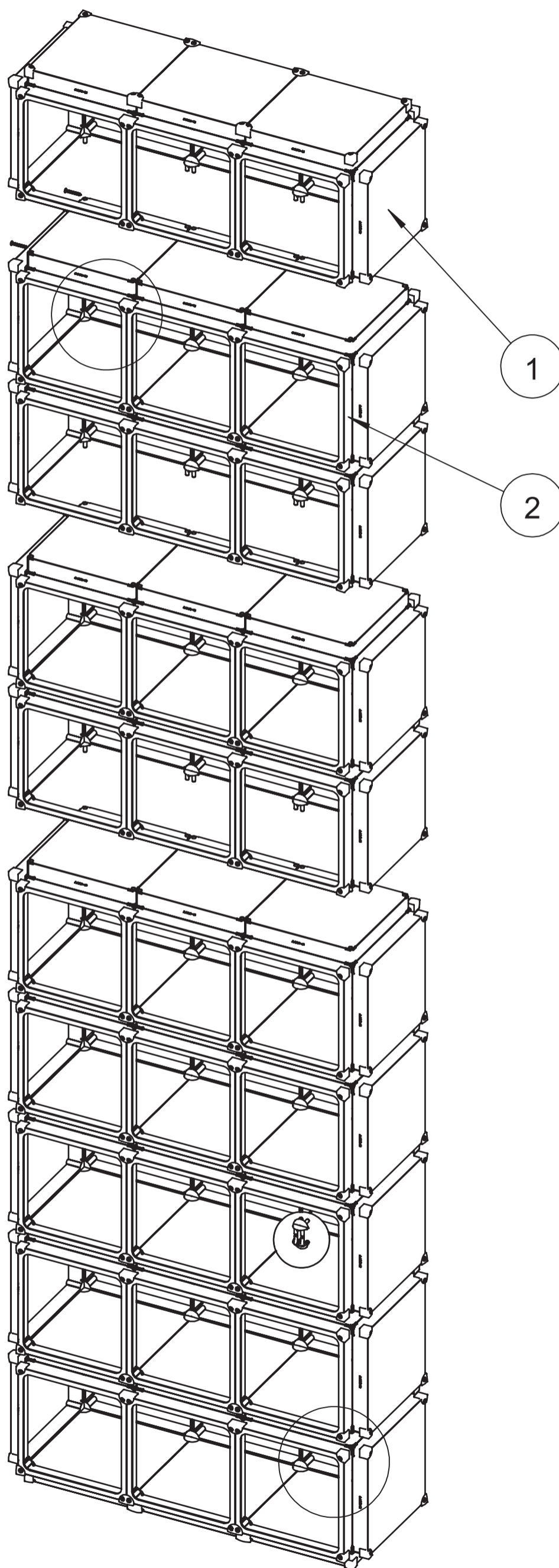



# Flaschen-Regal





# Stückliste



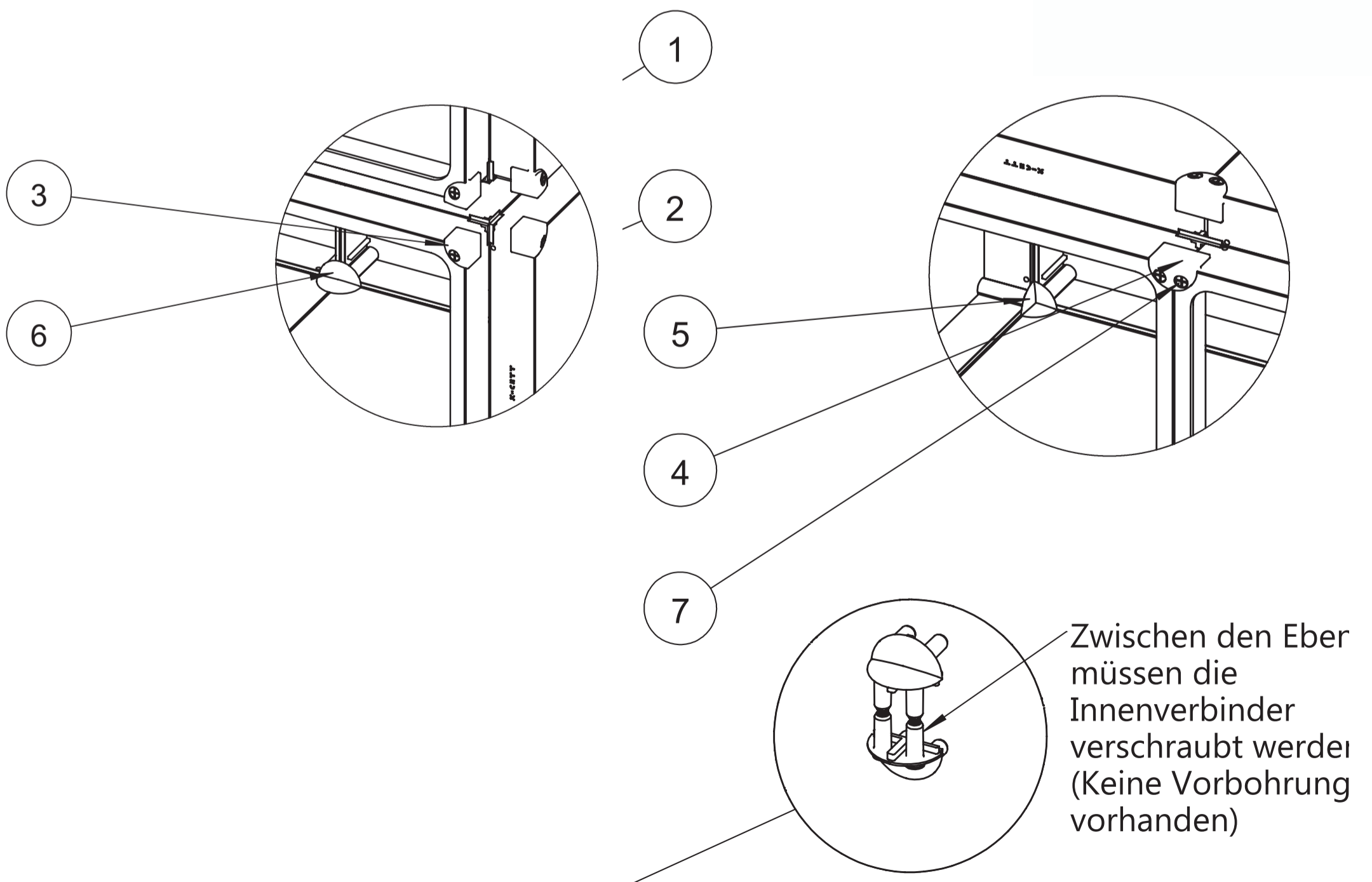



POS-NR.	BENENNUNG	ART.-NR.	MENGE	
1	Cassette	X101.04	83	
2	Cassette - Rahmen	X101.06	30	
3	Eckverbinder Senkkopf	X102.05	168	
4	Randverbinder Senkkopf	X102.07	88	
5	Innenverbinder 3-Fach	X102.13	80	
6	Innenverbinder 4-Fach	X102.14	80	
7	Schraube		452	

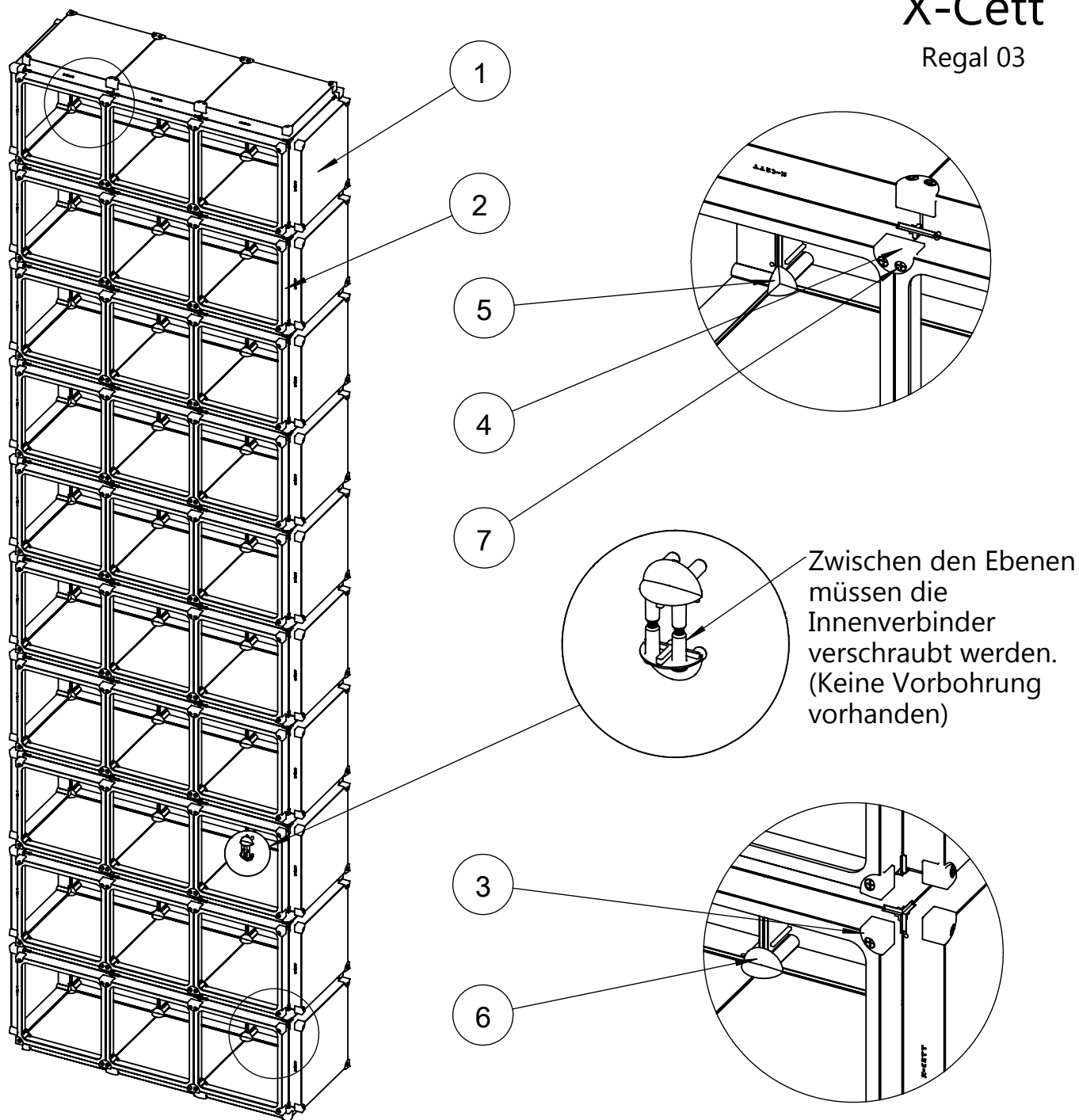

# X-Cett

Regal 03



POS-NR.	BENENNUNG	ART.-NR.	MENGE	
1	Cassette	X101.04	83	
2	Cassette - Rahmen	X101.06	30	
3	Eckverbinder Senkkopf	X102.05	168	
4	Randverbinder Senkkopf	X102.07	88	
5	Innenverbinder 3-Fach	X102.13	80	
6	Innenverbinder 4-Fach	X102.14	80	
7	Schraube		452	

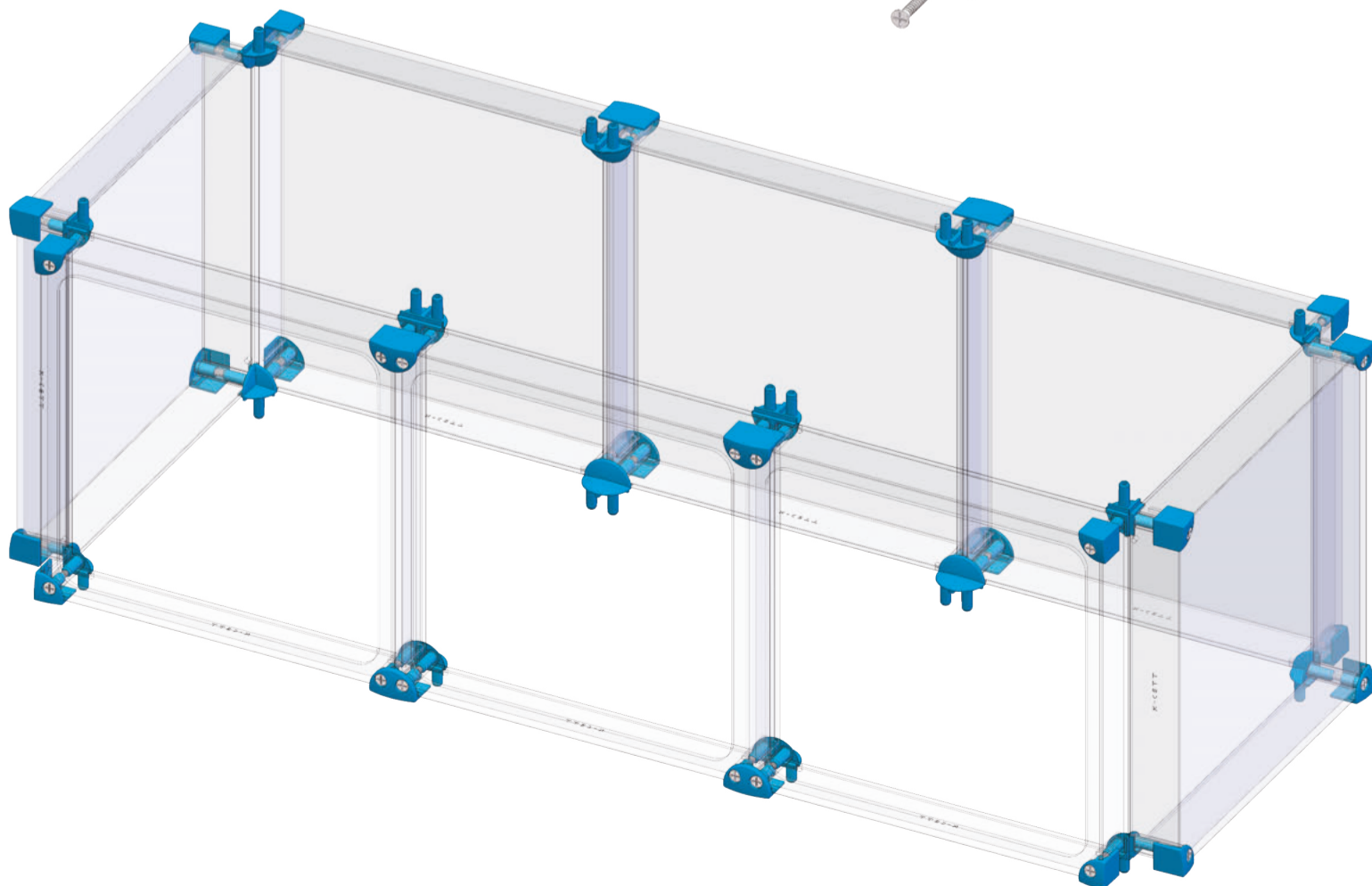
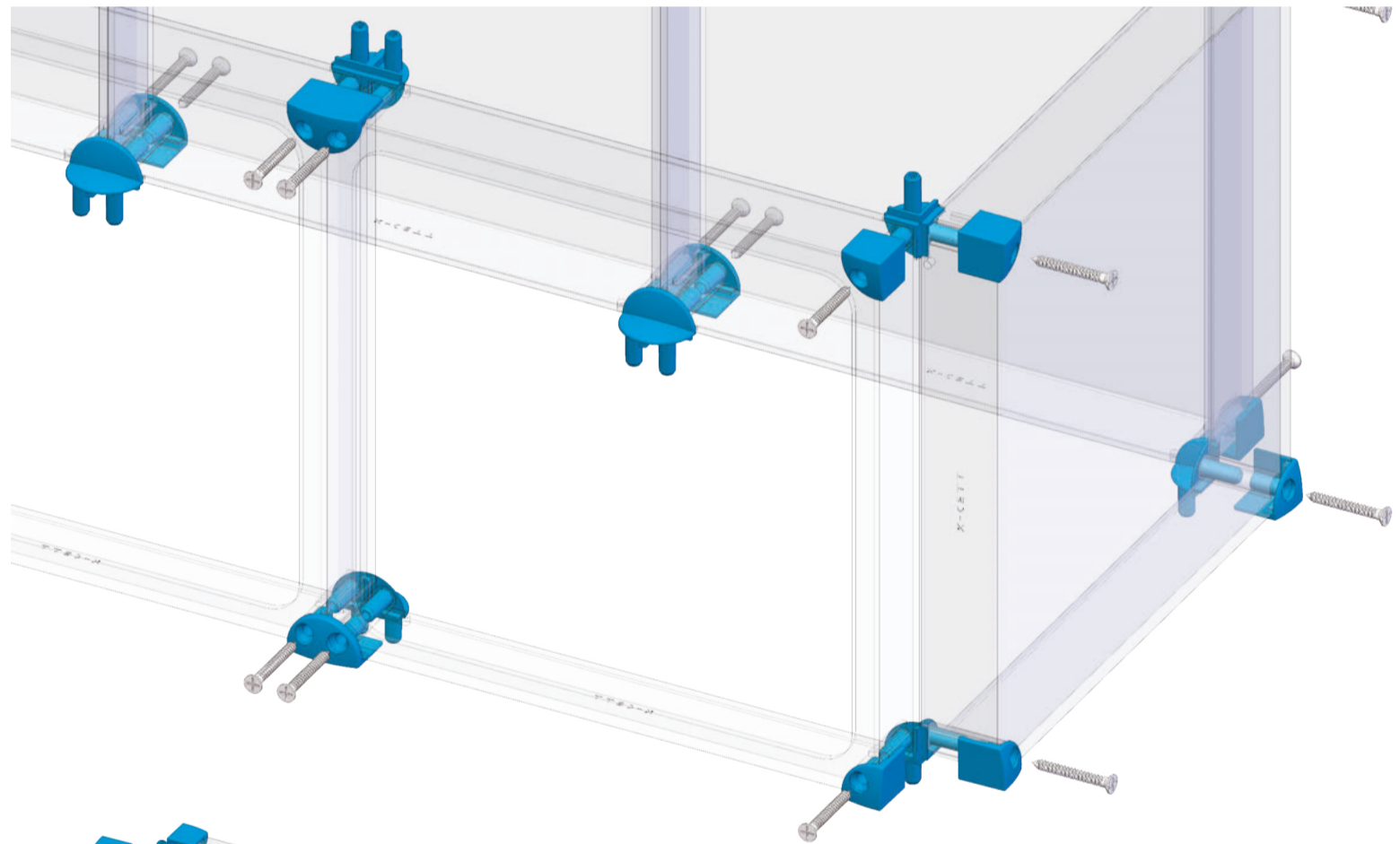
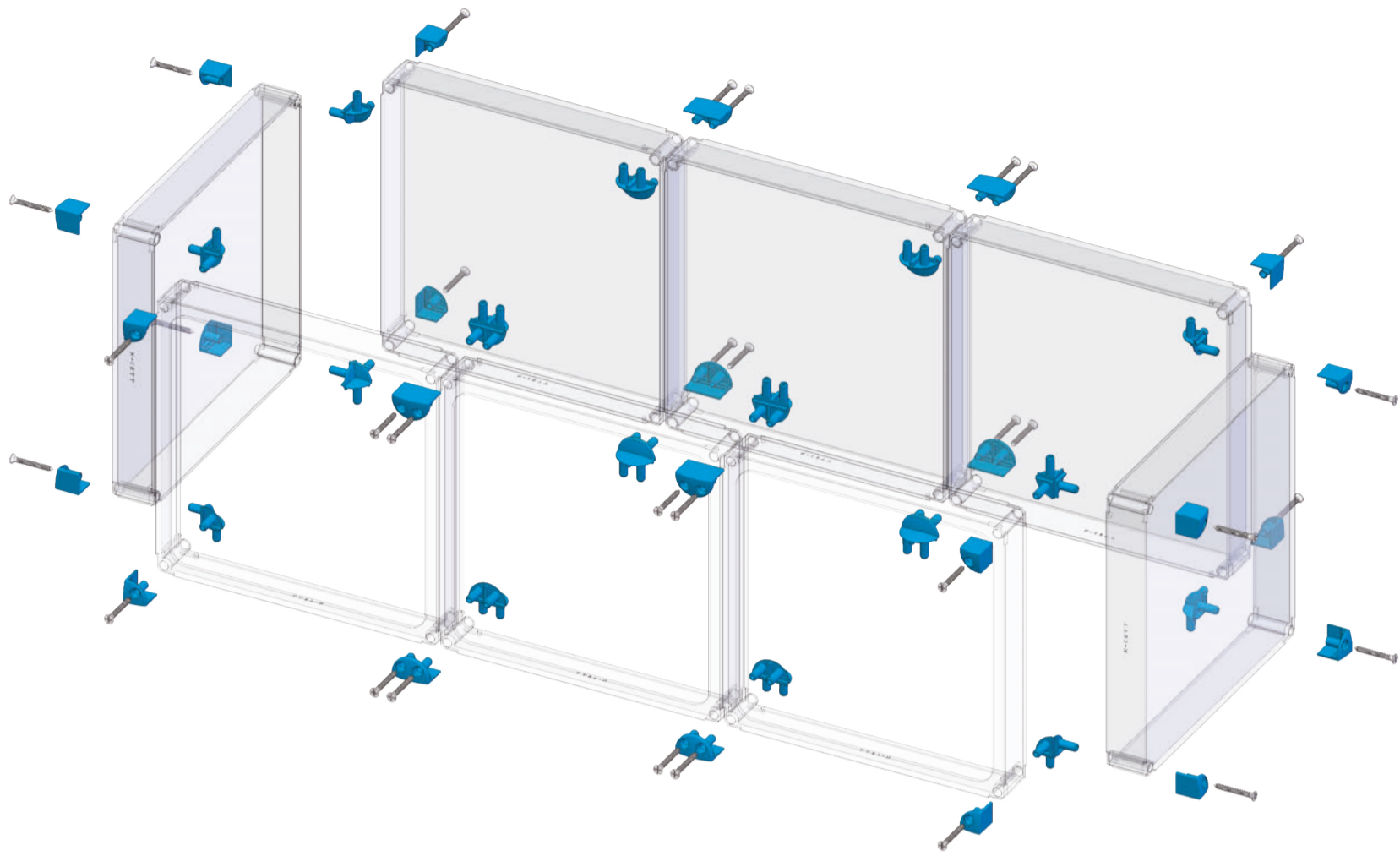

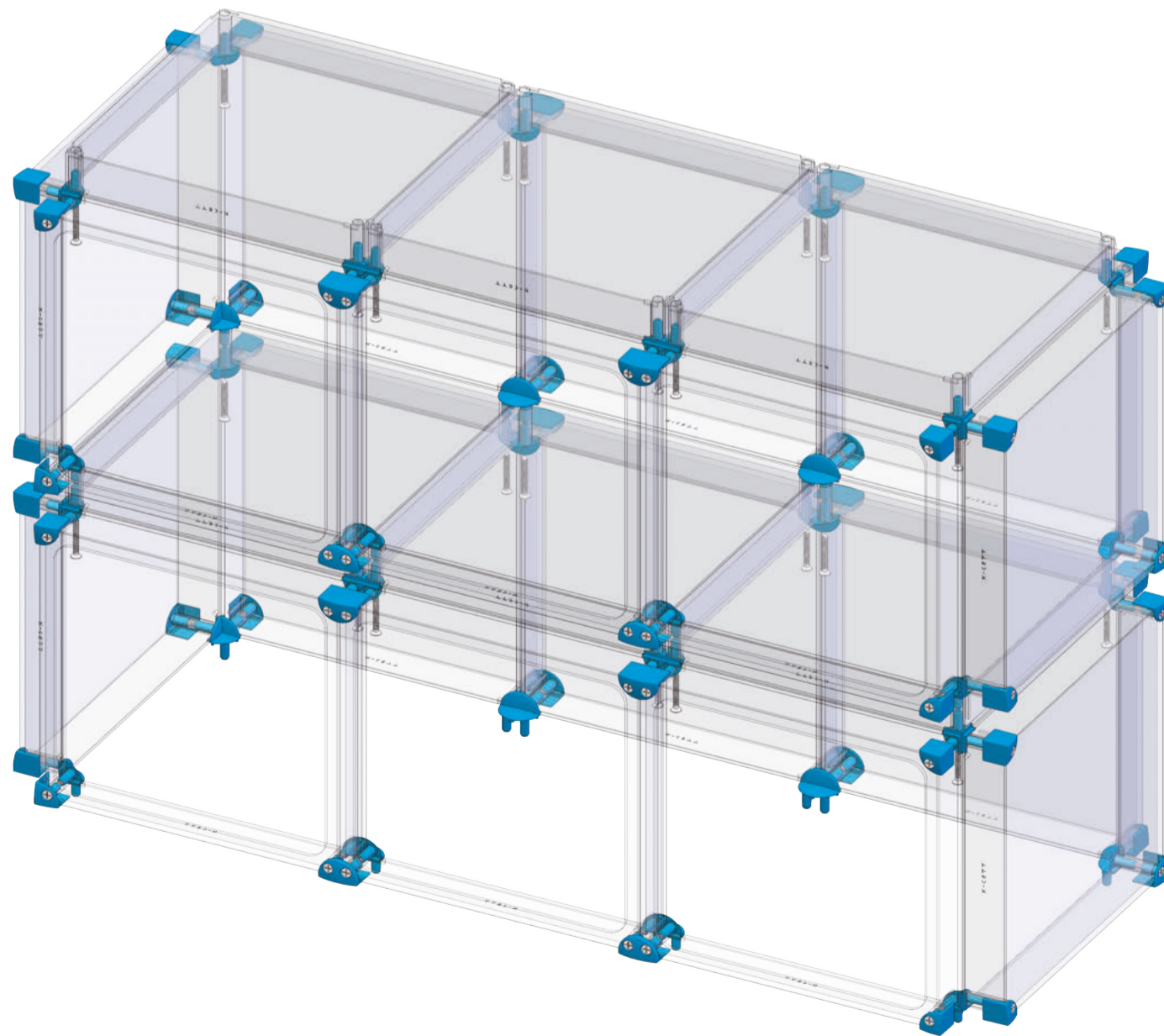
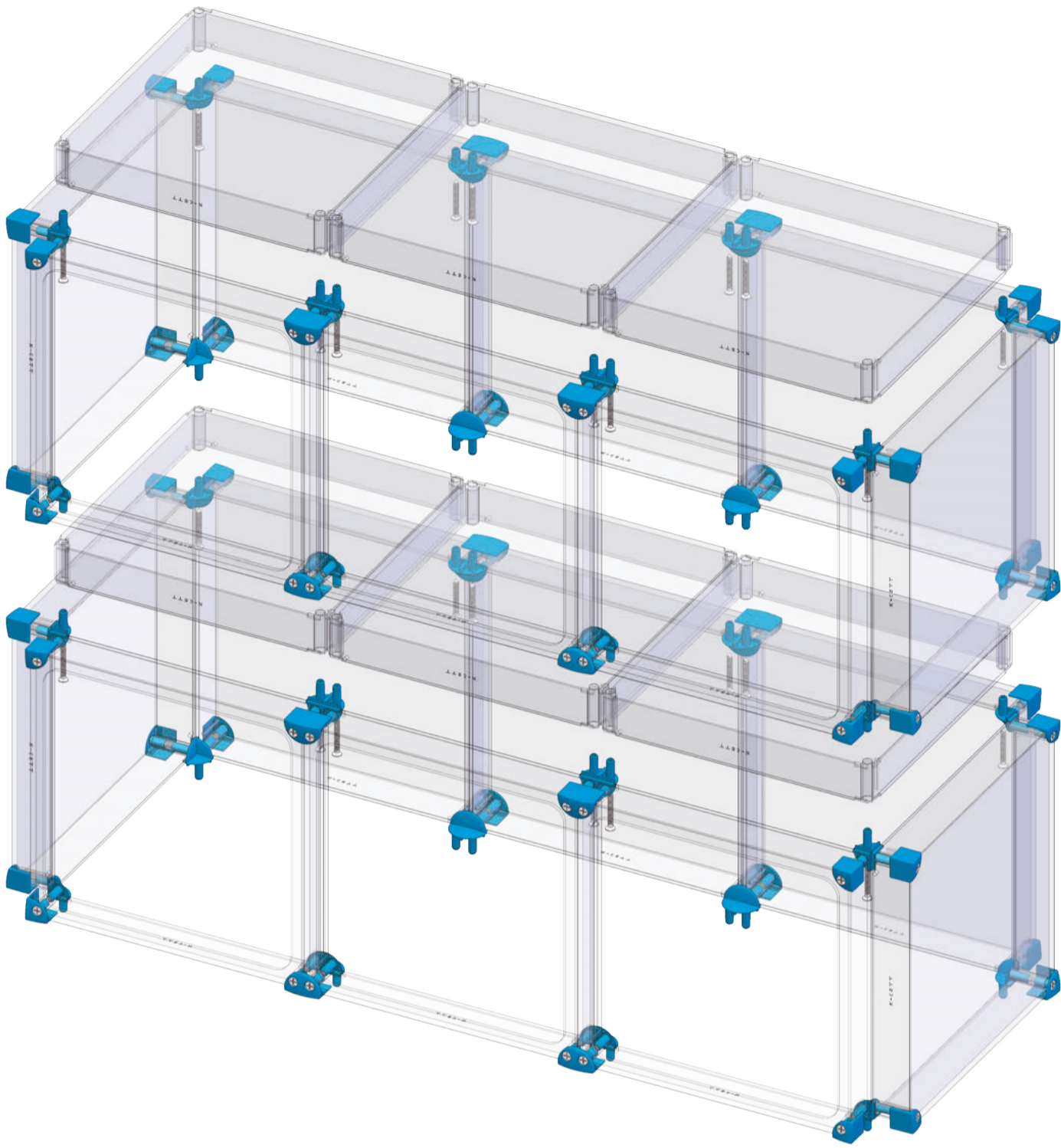

-Werkzeug  
-Reinigung

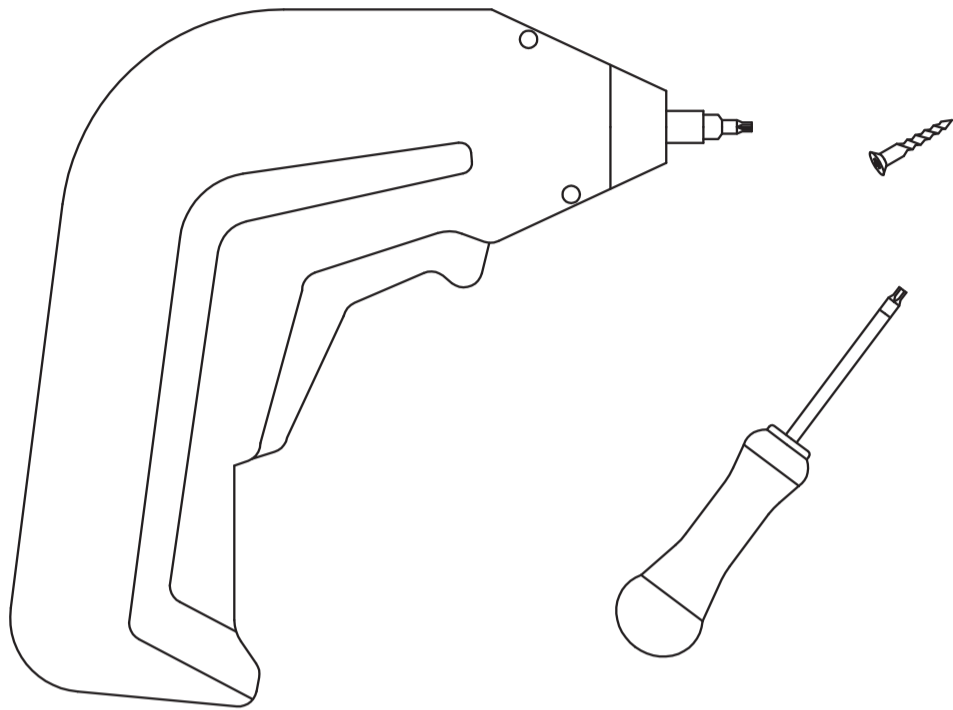

Benötigte Schrauben:  
SPAX T 10 ; 3 x 25

Benötigtes Werkzeug:  
Schraubendreher T 10

Maximales Drehmoment:  
1 Nm

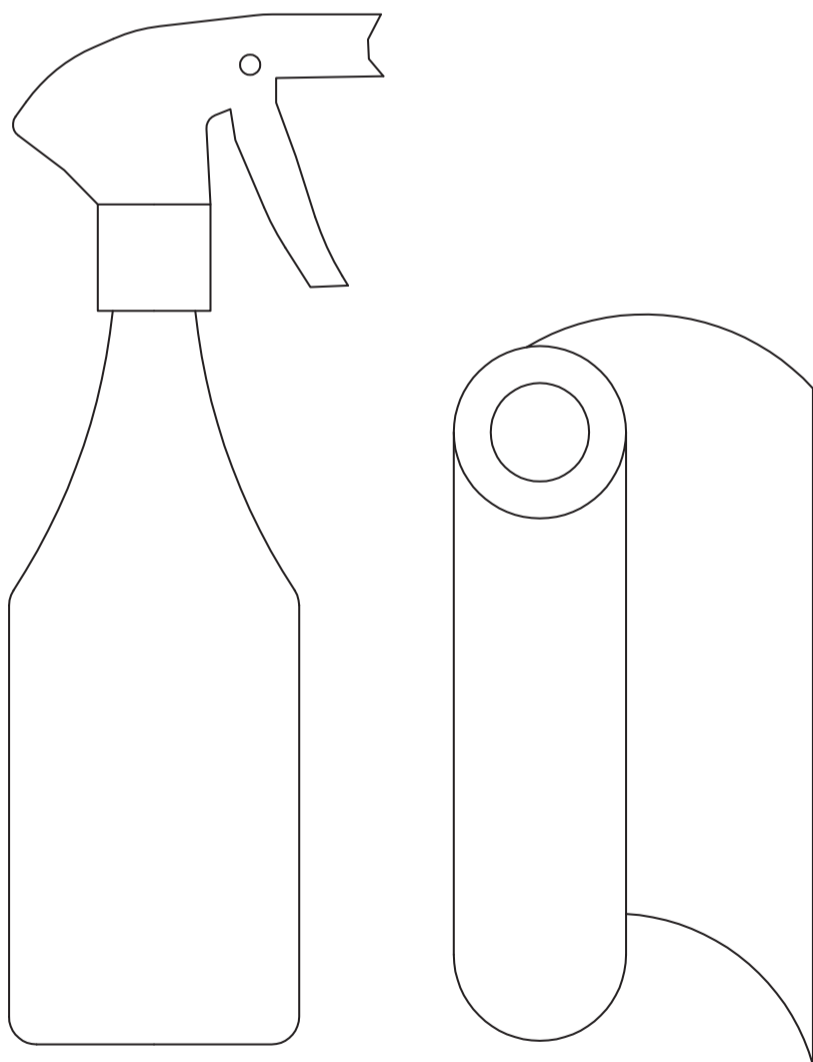

Reinigung der Systembauteile:

wie bei Autoscheinwerfern, mit  
Wasser und Shampoo und einem  
weichen Tuch.

xx niemals mit Lösungsmitteln xx

X-CETT Germany

Schreck Form e.K. Fon.: +49 6451 7186888 ; E-Mail: info@schreck-form.com ; www.X-Cett.com