

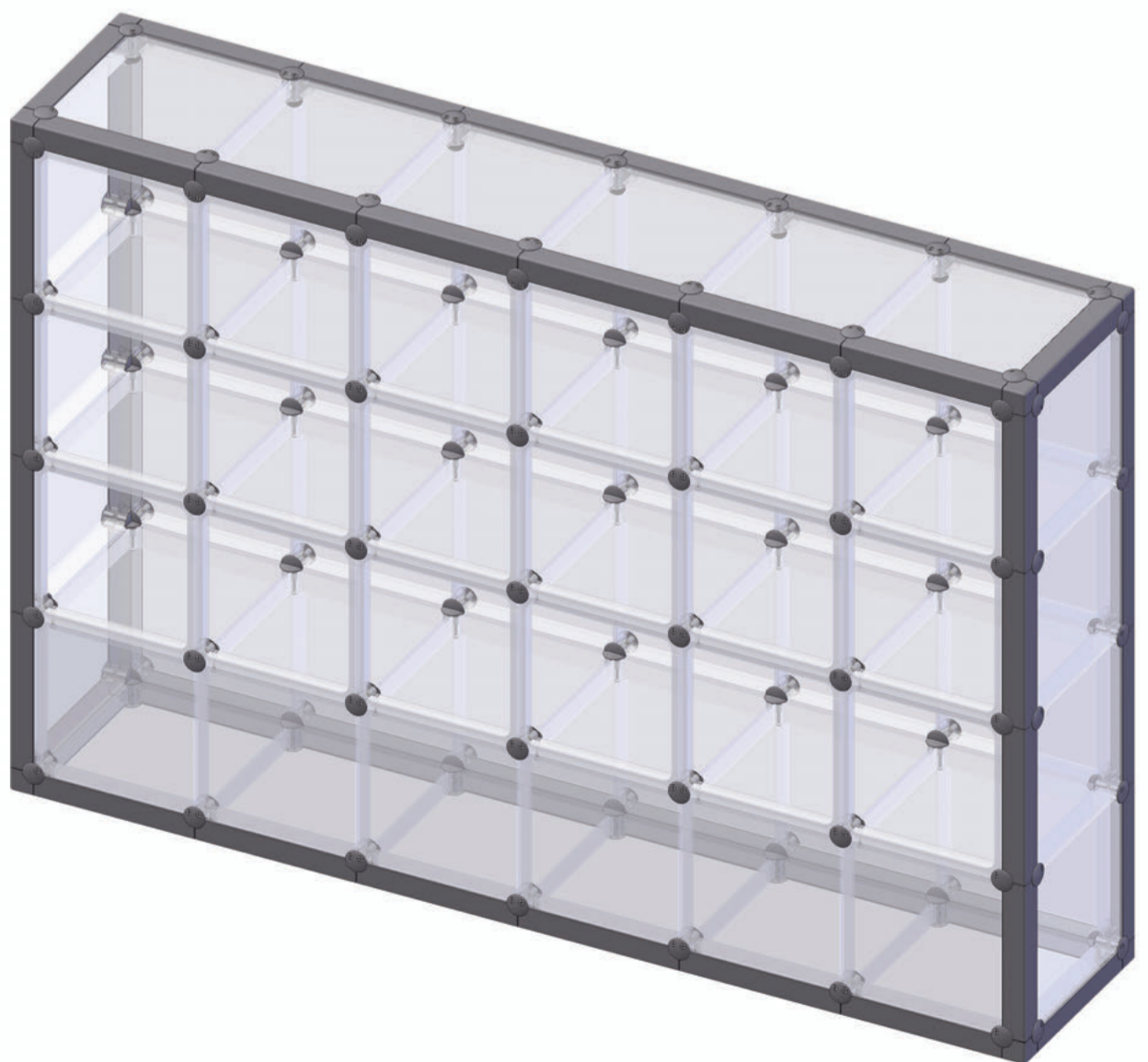

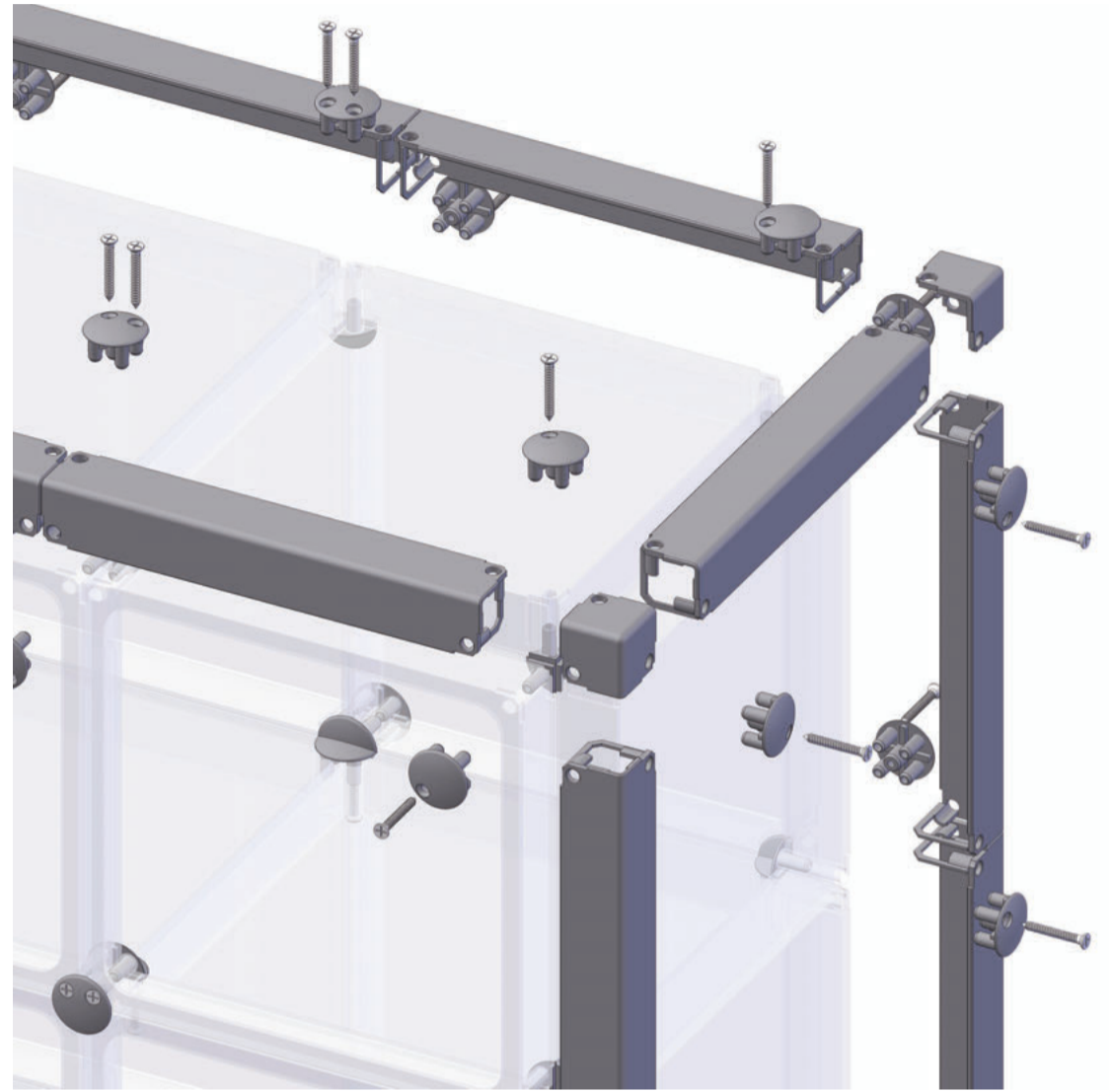

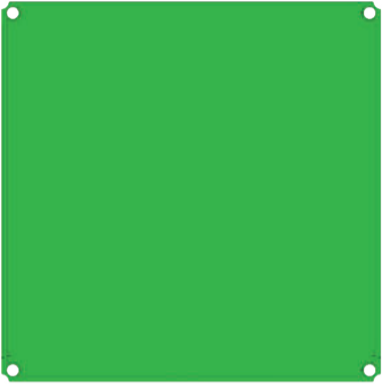

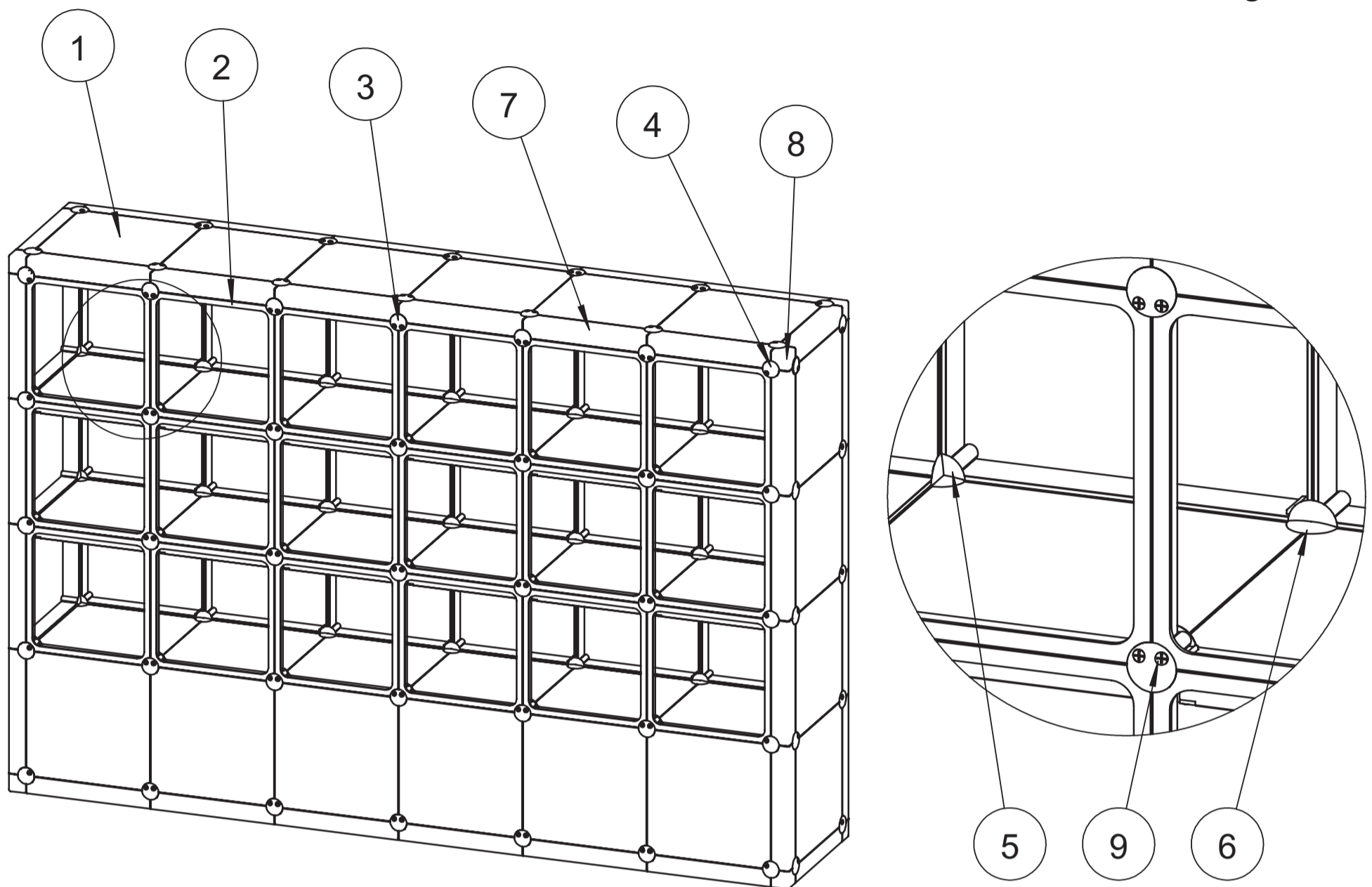



# Vitrine 4



# Stückliste



POS-NR.	BENENNUNG	ART.-NR.	MENGE	
1	Cassette	X101.04	68	
2	Cassette - Rahmen	X101.06	18	
3	Standardverbinder 2 Senkungen	X102.03	70	
4	Standardverbinder 1 Senkung	X102.04	48	
5	Innenverbinder 3-Fach	X102.13	20	
6	Innenverbinder 4-Fach	X102.14	50	
7	Eckschiene	X103.01	44	
8	Kofferecke	X103.03	8	
9	Schraube		260	



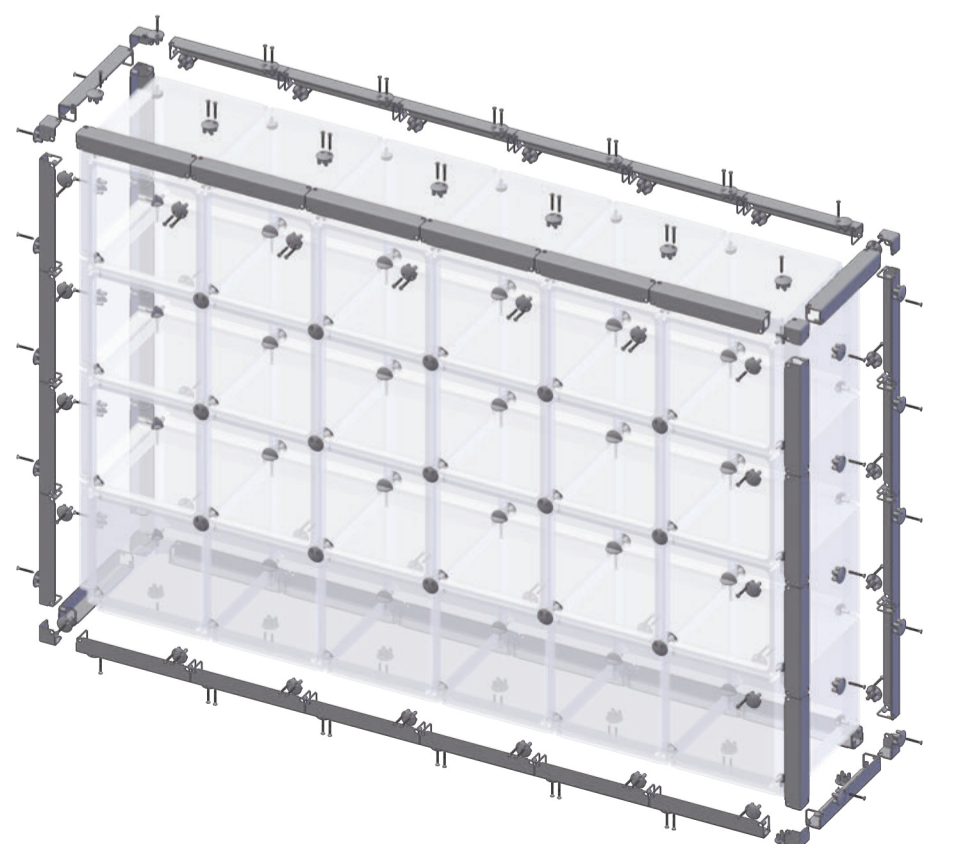
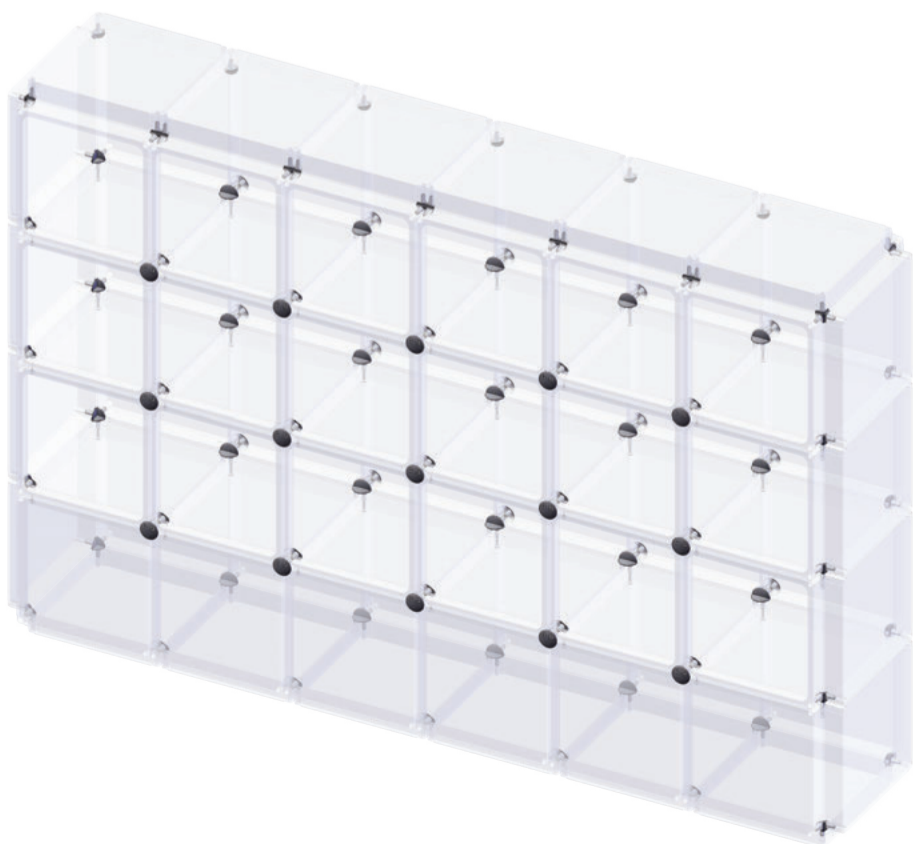
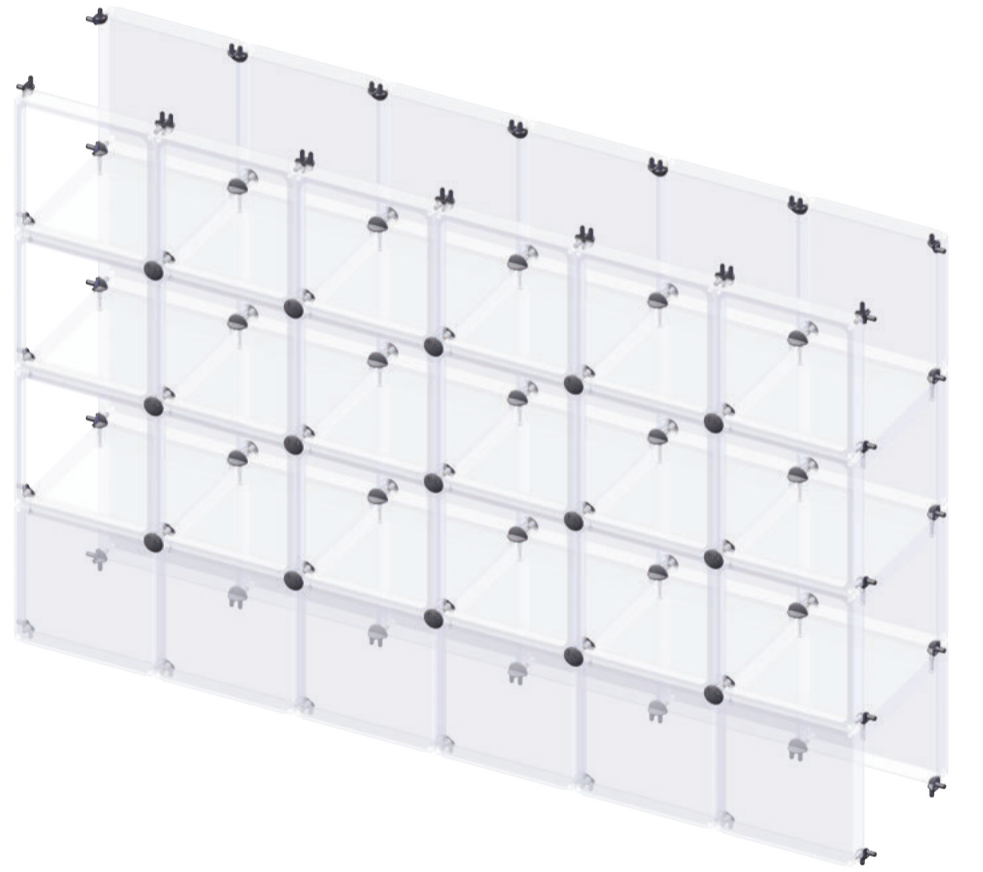
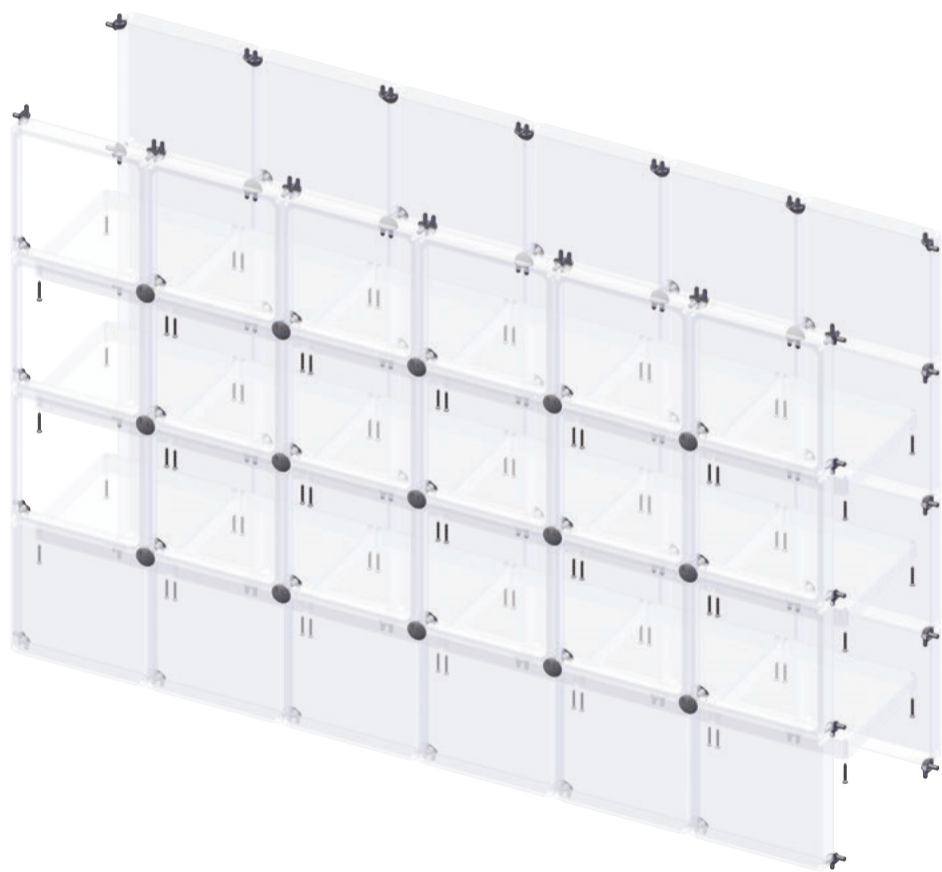
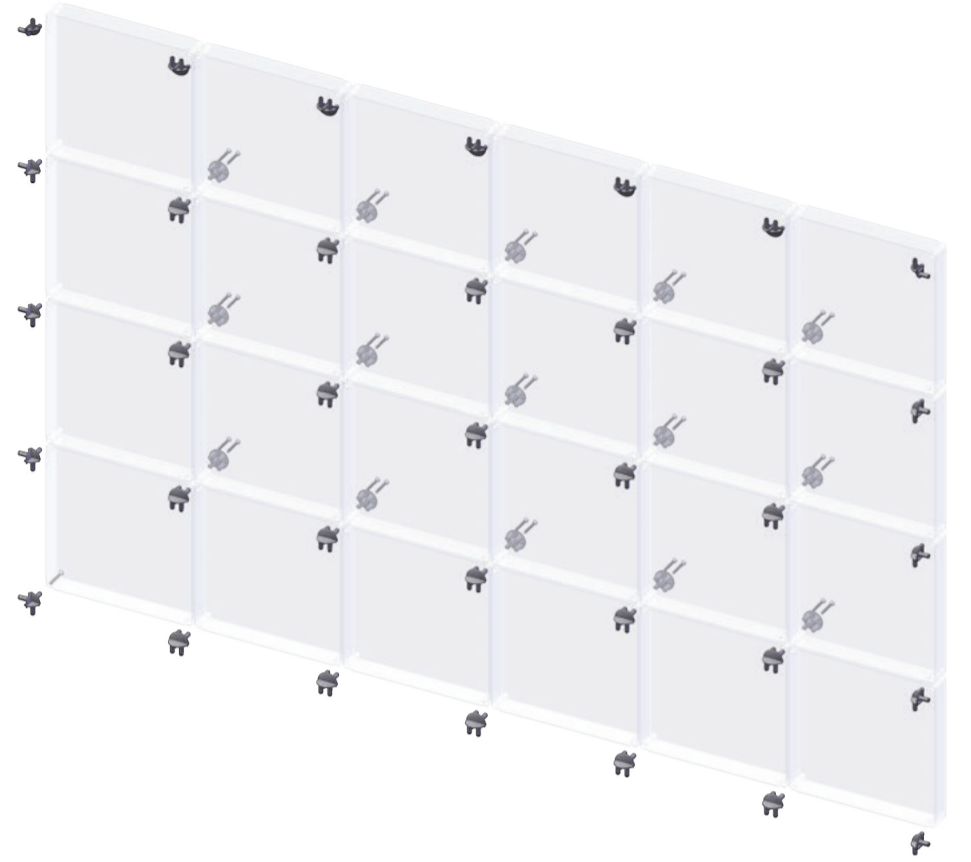
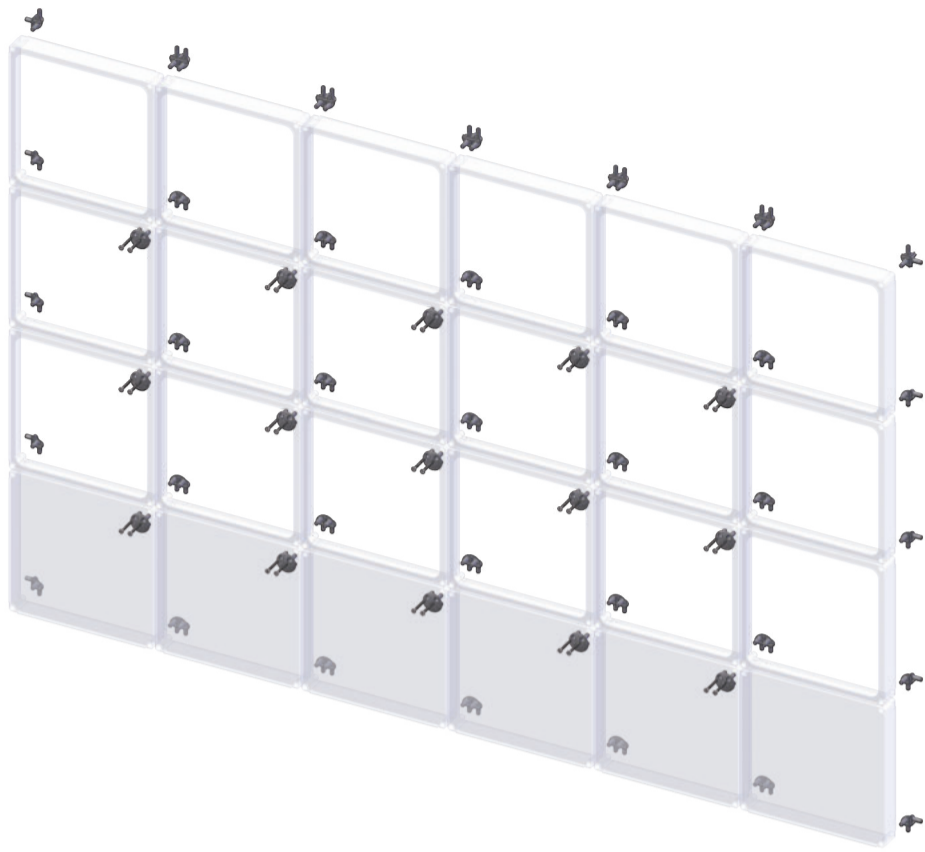

-Werkzeug  
-Reinigung

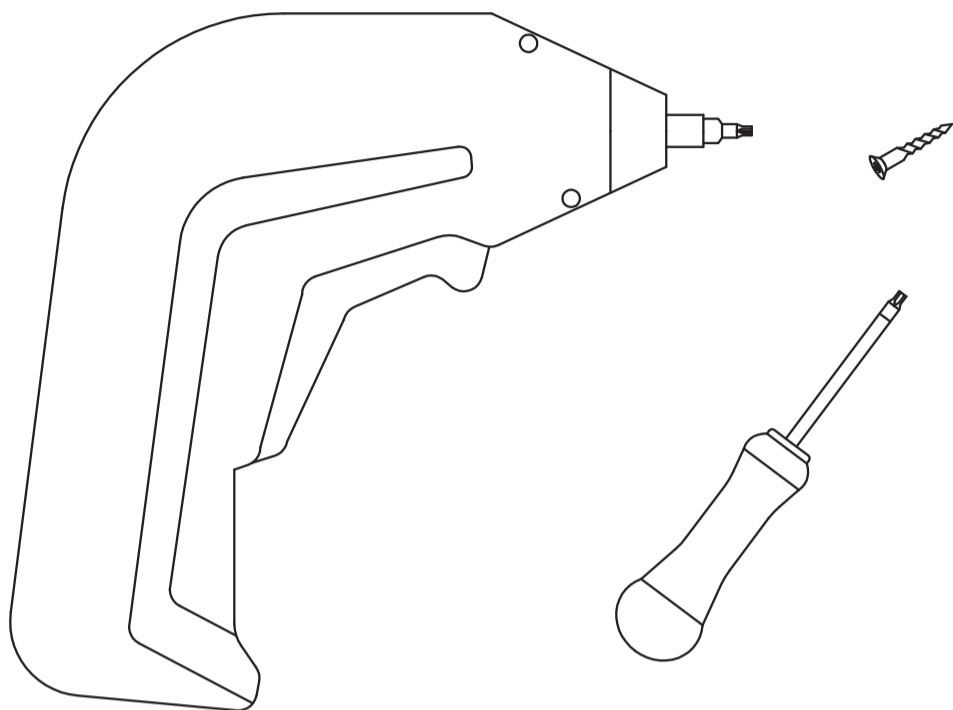

Benötigte Schrauben:  
SPAX T 10 ; 3 x 25

Benötigtes Werkzeug:  
Schraubendreher T 10

Maximales Drehmoment:  
1 Nm

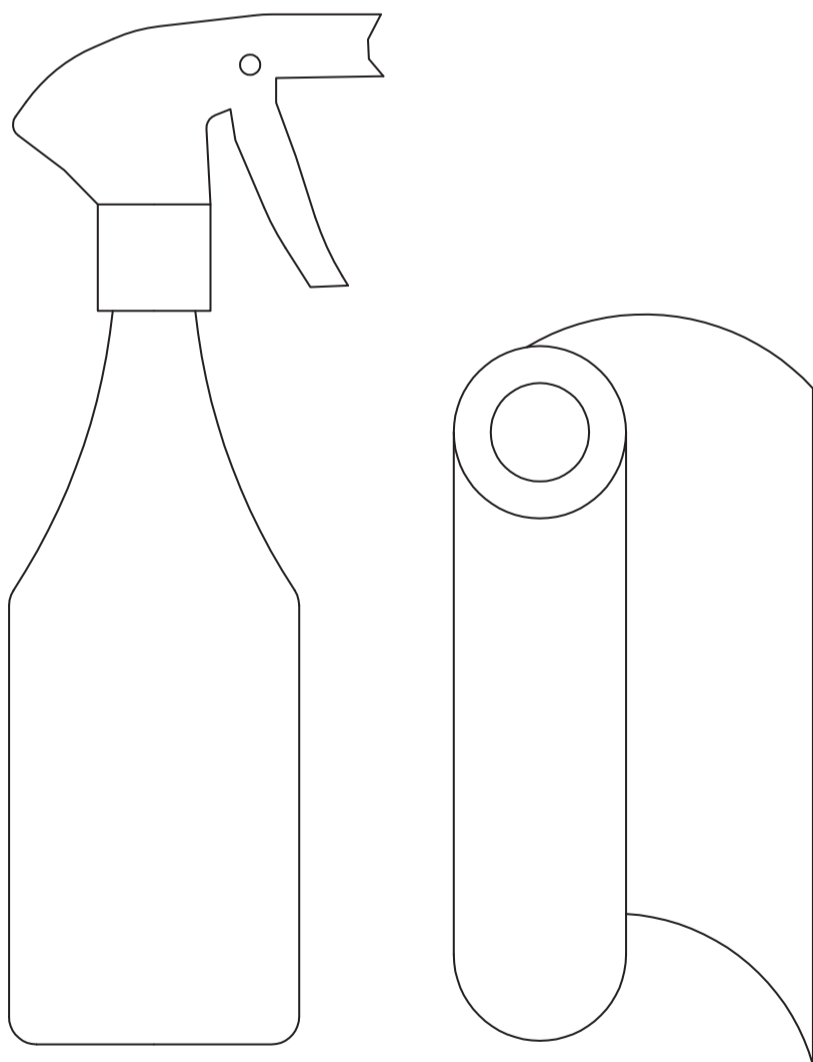

Reinigung der Systembauteile:

wie bei Autoscheinwerfern, mit  
Wasser und Shampoo und einem  
weichen Tuch.

xx niemals mit Lösungsmitteln xx

X-CETT Germany

Schreck Form e.K. Fon.: +49 6451 7186888 ; E-Mail: info@schreck-form.com ; www.X-Cett.com